



Diamo forma alle tue idee
Catalogo Mavis

mavis
PROFILI IN PLASTICA



la sapienza è figliola dell'esperienza

LEONARDO DA VINCI

Da più di 40 anni progettiamo e realizziamo profili in plastica

La nostra esperienza nella lavorazione di molti materiali plastici e con diversi processi produttivi ci consente di trovare velocemente la soluzione ideale per il cliente. La metodologia di lavoro impostata da ormai tanti anni sulla qualità, ci consente di realizzare prodotti estremamente affidabili e sicuri.

Diamo forma alle tue idee

Se devi realizzare un nuovo prodotto personalizzato, noi ti accompagneremo attraverso tutte le fasi della lavorazione. Dal progetto, alla scelta del materiale plastico, al prototipo, alla costruzione della matrice, fino alla realizzazione del profilo in plastica; tutti i passaggi verranno da noi coordinati. La realizzazione di prodotti personalizzati consente di ottimizzare i costi rendendo il profilo più competitivo.

Soluzioni innovative in plastica

L'esperienza che ci permette di poter accettare continuamente nuove sfide realizzando progetti tecnologicamente sempre più complessi. Non finiamo mai di studiare e aggiornarci sulle ultime novità in fatto di materie prime, processi e prodotti. Per questo i nostri clienti possono contare su profili all'avanguardia e veramente innovativi capaci di dare nuove soluzioni al loro progetto.

Il profilo che cercavi

Se stai cercando un nuovo profilo in plastica, oppure se lo stai progettando, nel nostro "Catalogo Profili e Guarnizioni" potrai trovare molti articoli già disponibili e diverse idee per migliorare il tuo progetto. Abbiamo anche molti altri articoli a disposizione, quindi, se in questo catalogo non trovi quello di tuo interesse, contattaci.



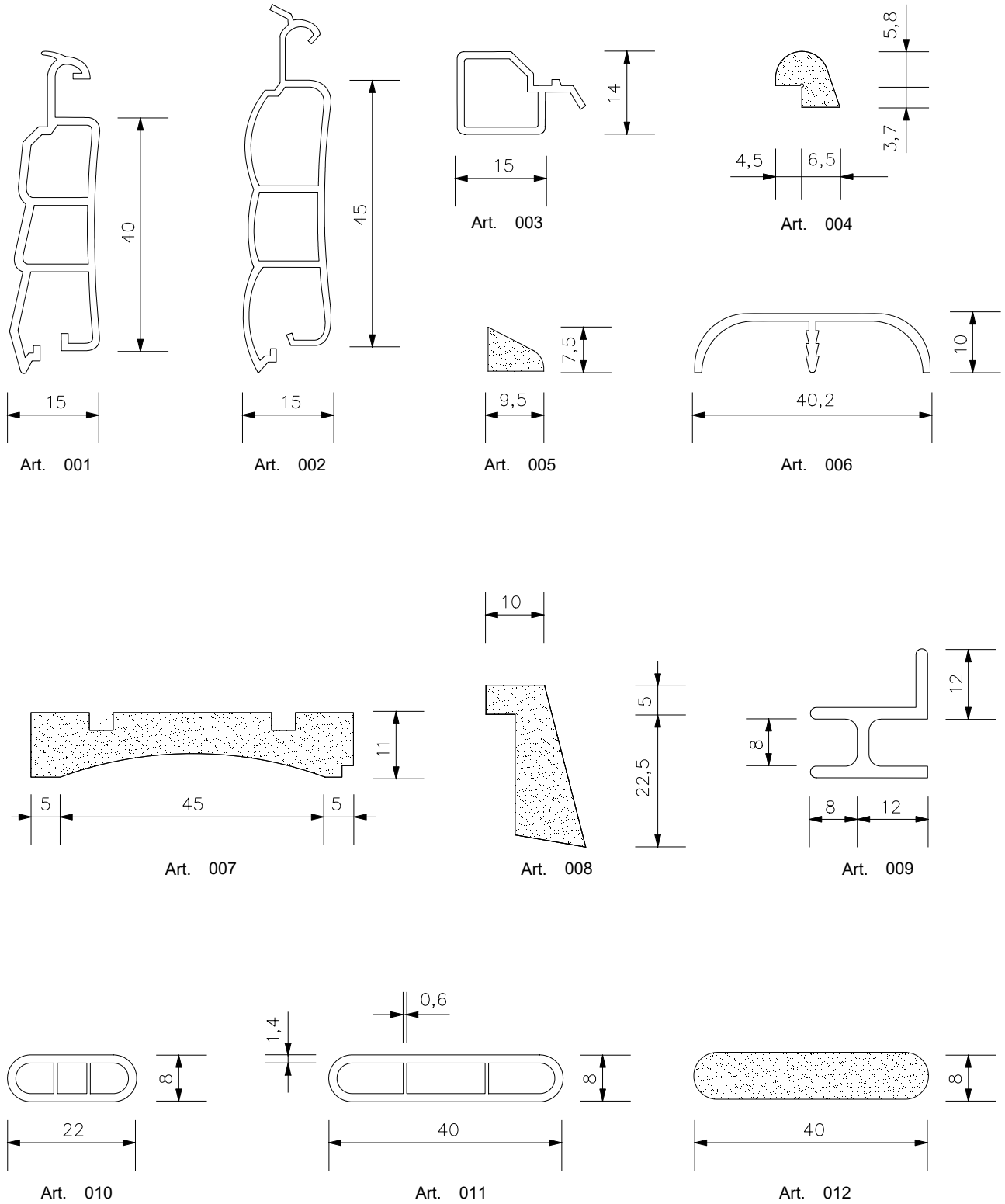

■ FLESSIBILE *FLEXIBLE 1* □ FLESSIBILE *FLEXIBLE 2* □ RIGIDO *RIGID* ▣ ESPANSO *EXPANDED*

▶ A termini di legge, ci riserviamo la proprietà di questi disegni con il divieto di riprodurli e di cederli a terzi senza la nostra autorizzazione.

▶ We reserve all rights on the property of these drawings with warning not to reproduce or to deliver to other parties without our authorization.

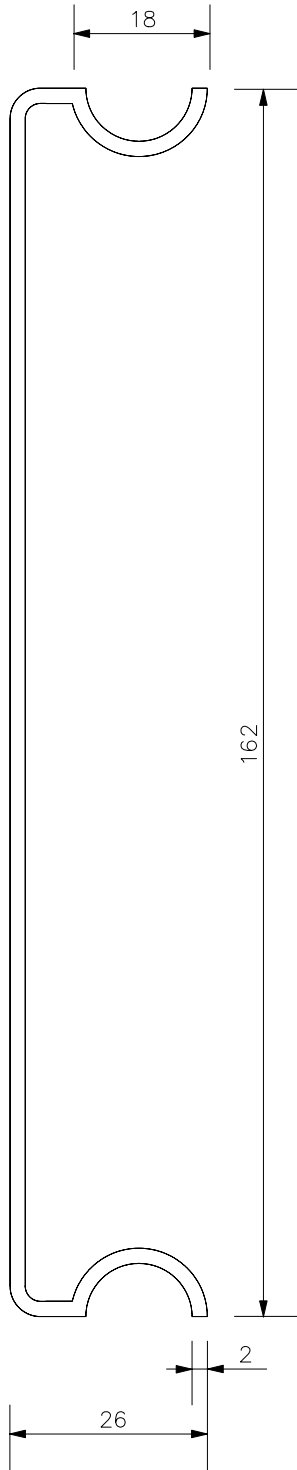

Art. 013

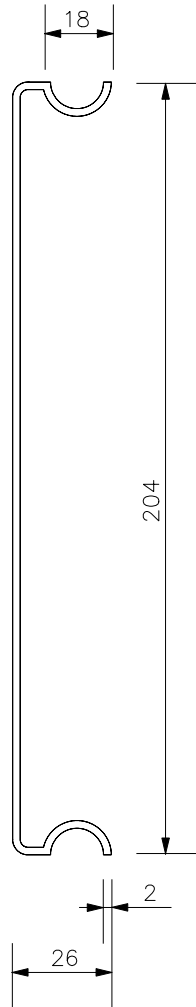

Art. 014
scala 1:2

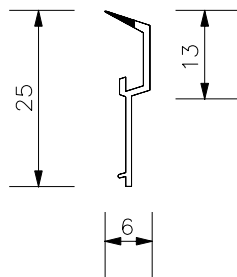

Art. 015

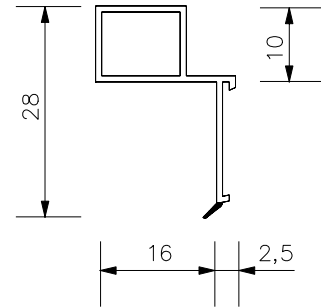

Art. 016

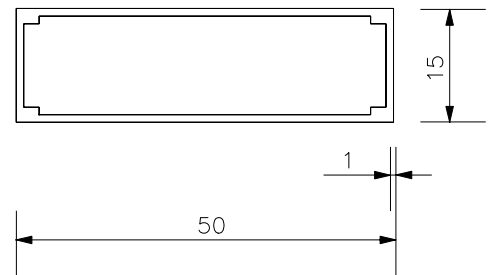

Art. 017

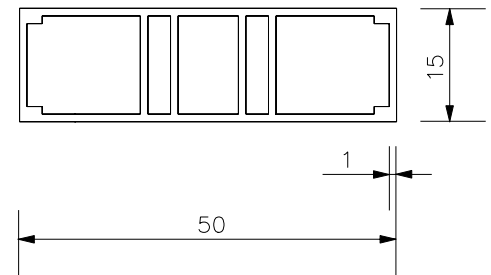

Art. 018

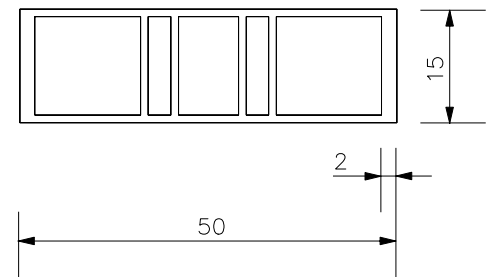

Art. 019

FLESSIBILE *FLEXIBLE 1*
 FLESSIBILE *FLEXIBLE 2*
 RIGIDO *RIGID*
 ESPANSO *EXPANDED*

▶ A termini di legge, ci riserviamo la proprietà di questi disegni con il divieto di riprodurli e di cederli a terzi senza la nostra autorizzazione.

▶ We reserve all rights on the property of these drawings with warning not to reproduce or to deliver to other parties without our authorization.

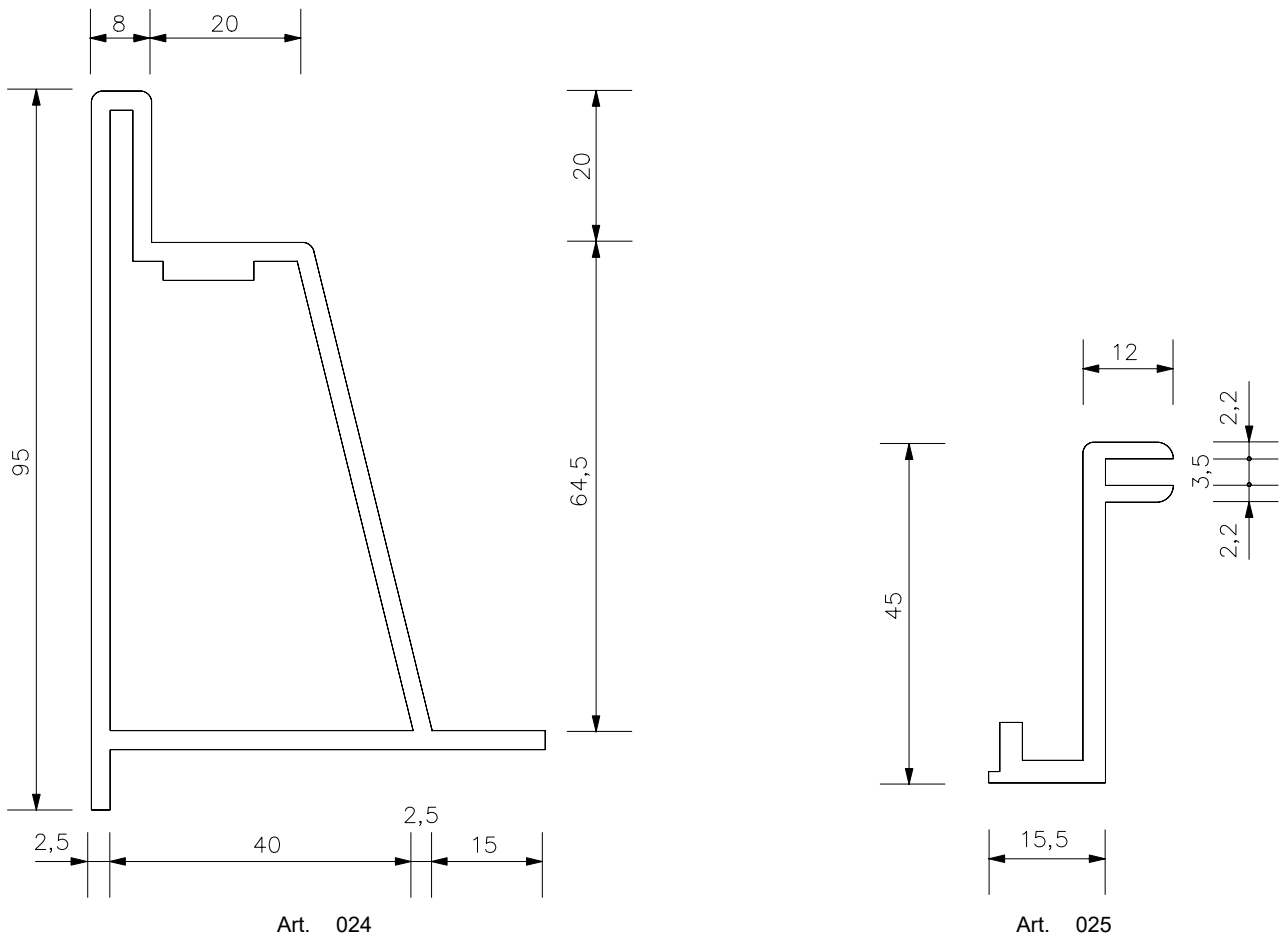
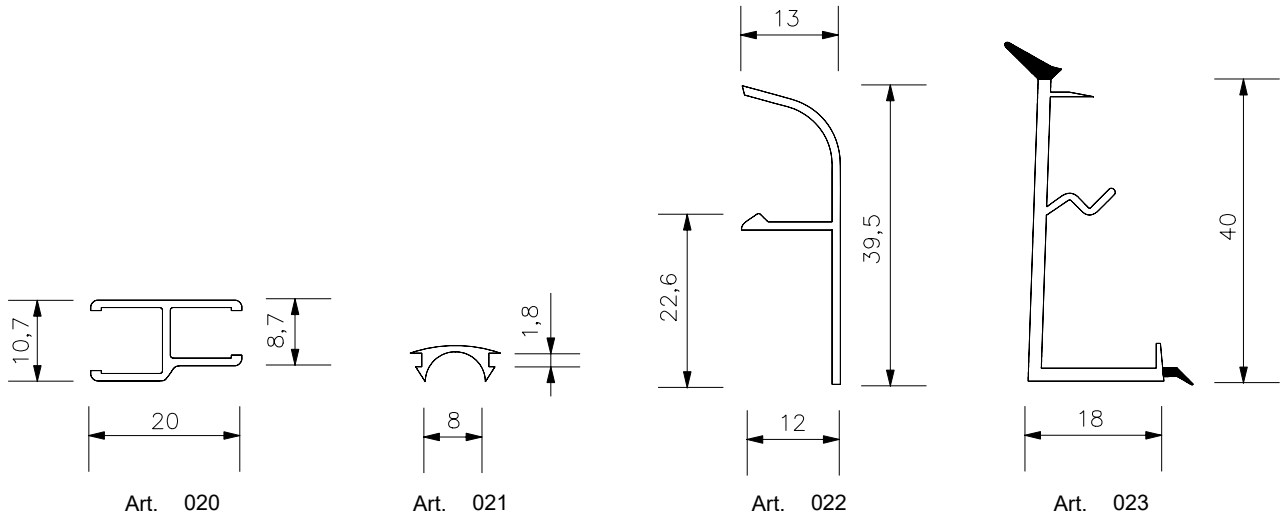

FLESSIBILE *FLEXIBLE 1*
 FLESSIBILE *FLEXIBLE 2*
 RIGIDO *RIGID*
 ESPANSO *EXPANDED*

▶ A termini di legge, ci riserviamo la proprietà di questi disegni con il divieto di riprodurli e di cederli a terzi senza la nostra autorizzazione.

▶ We reserve all rights on the property of these drawings with warning not to reproduce or to deliver to other parties without our authorization.

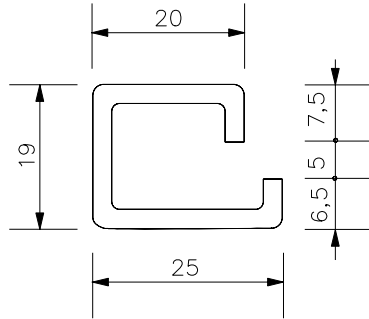

Art. 026

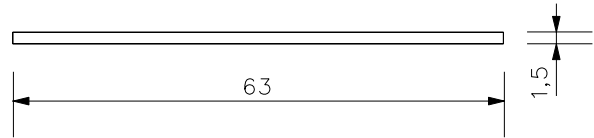

Art. 028

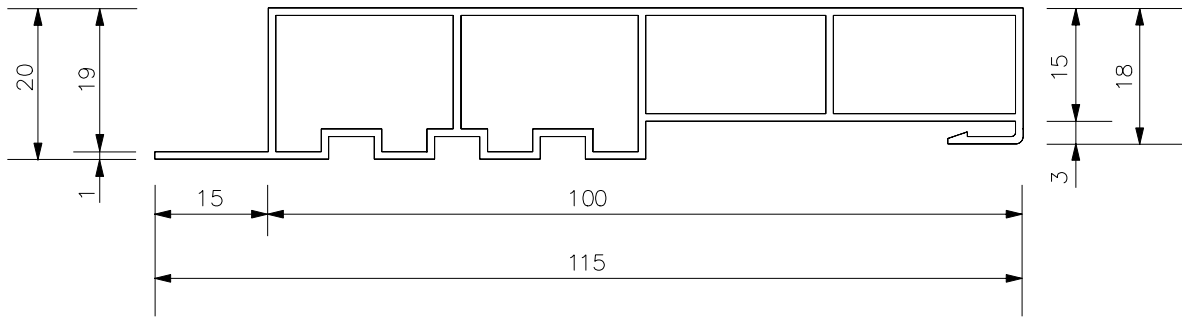

Art. 027

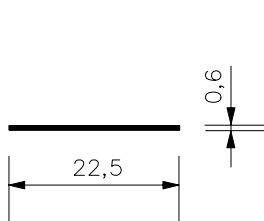

Art. 029

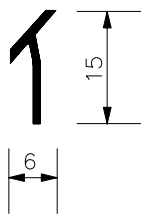

Art. 030

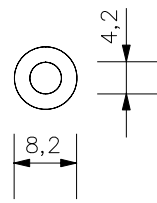

Art. 031

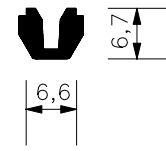

Art. 032

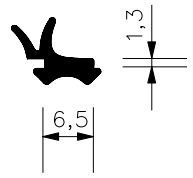

Art. 033

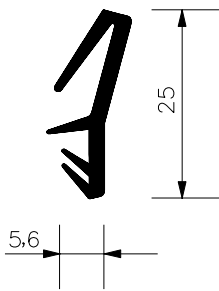

Art. 034

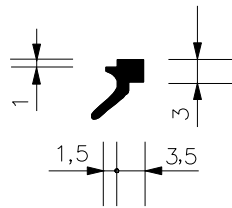

Art. 035

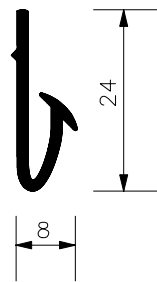

Art. 036

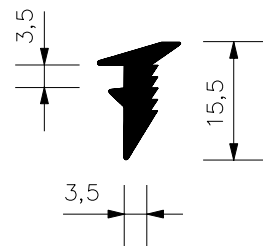

Art. 037

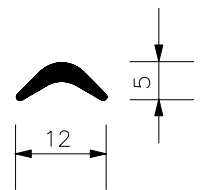

Art. 038

■ FLESSIBILE FLEXIBLE 1 □ FLESSIBILE FLEXIBLE 2 □ RIGIDO RIGID ▣ ESPANSO EXPANDED

▶ A termini di legge, ci riserviamo la proprietà di questi disegni con il divieto di riprodurli e di cederli a terzi senza la nostra autorizzazione.

▶ We reserve all rights on the property of these drawings with warning not to reproduce or to deliver to other parties without our authorization.

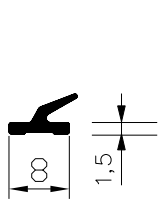

Art. 039

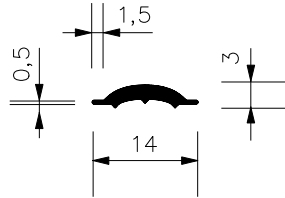

Art. 040

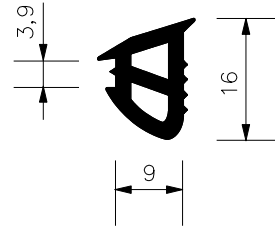

Art. 041

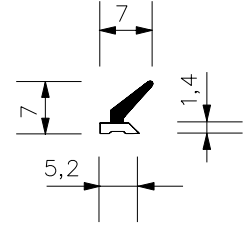

Art. 042

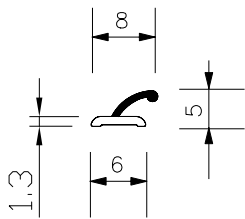

Art. 043

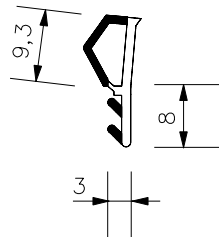

Art. 044

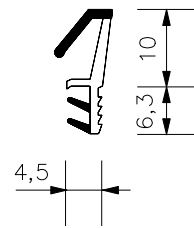

Art. 045

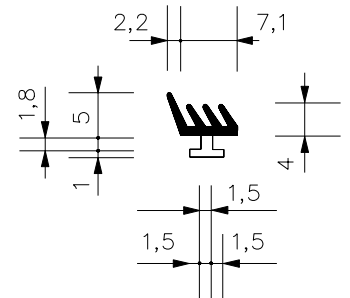

Art. 046

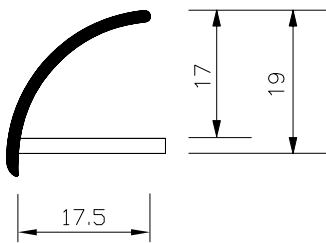

Art. 047

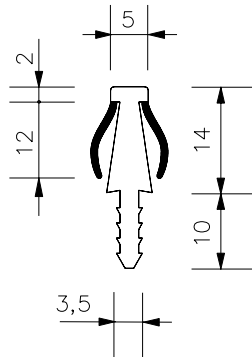

Art. 048

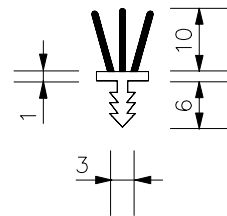

Art. 049

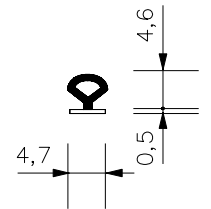

Art. 050

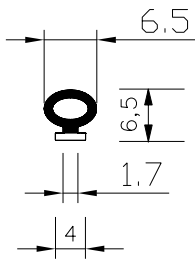

Art. 051

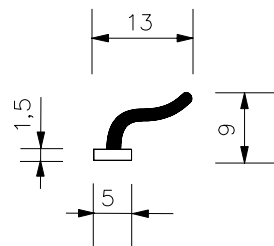

Art. 052

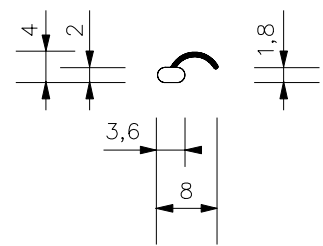

Art. 053

■ FLESSIBILE *FLEXIBLE 1* □ FLESSIBILE *FLEXIBLE 2* □ RIGIDO *RIGID* ▣ ESPANSO *EXPANDED*

▶ A termini di legge, ci riserviamo la proprietà di questi disegni con il divieto di riprodurli e di cederli a terzi senza la nostra autorizzazione.

▶ We reserve all rights on the property of these drawings with warning not to reproduce or to deliver to other parties without our authorization.

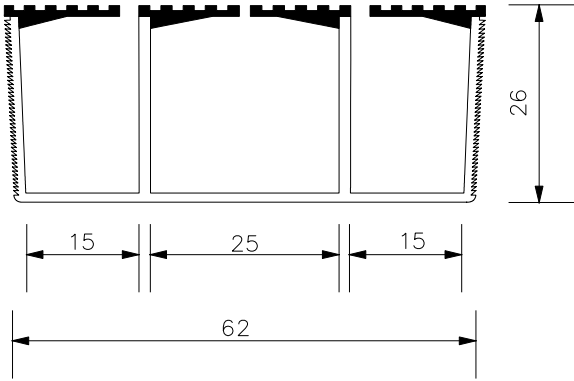

Art. 054

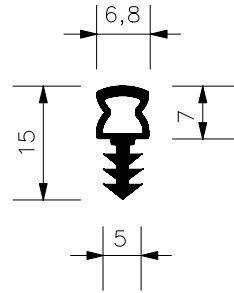

Art. 055

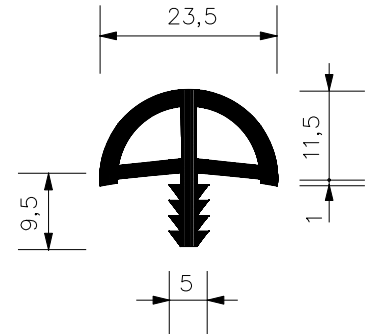

Art. 056

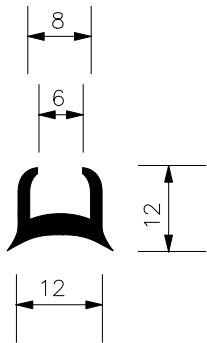

Art. 057

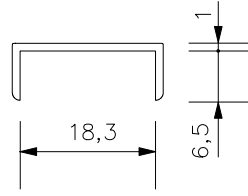

Art. 058

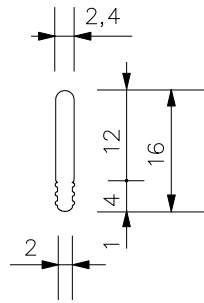

Art. 059

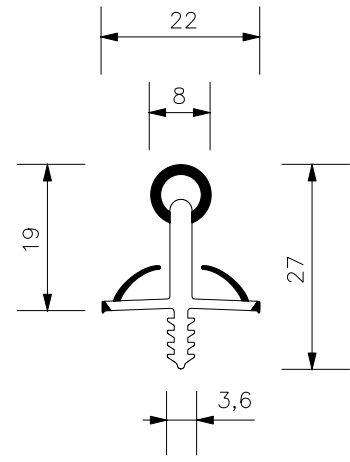

Art. 060

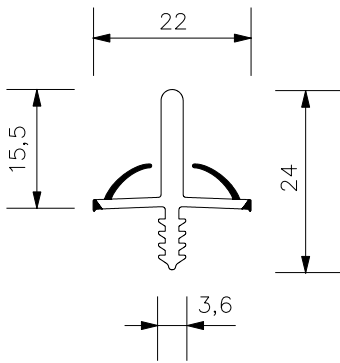

Art. 061

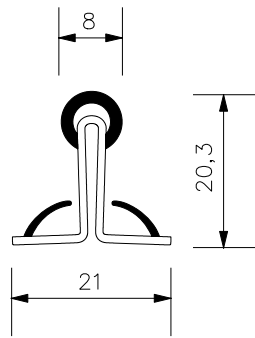

Art. 062

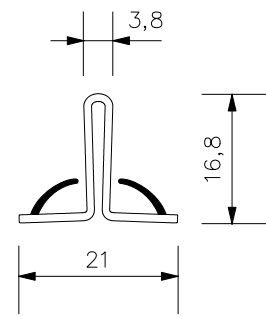

Art. 063

■ FLESSIBILE FLEXIBLE 1 □ FLESSIBILE FLEXIBLE 2 □ RIGIDO RIGID ▣ ESPANSO EXPANDED

▶ A termini di legge, ci riserviamo la proprietà di questi disegni con il divieto di riprodurli e di cederli a terzi senza la nostra autorizzazione.

▶ We reserve all rights on the property of these drawings with warning not to reproduce or to deliver to other parties without our authorization.

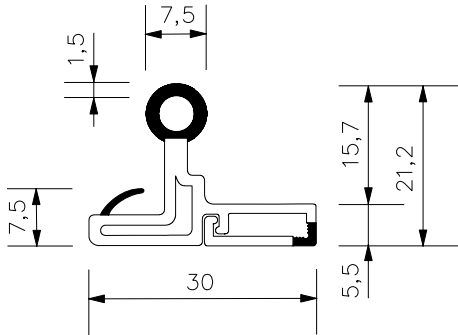

Art. 064

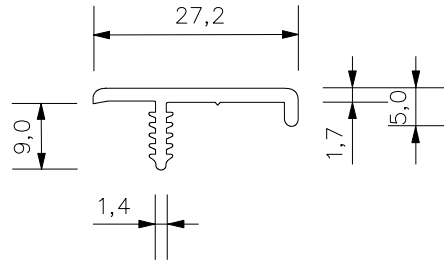

Art. 065

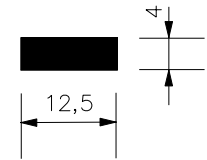

Art. 069

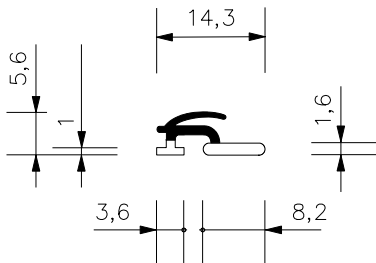

Art. 066

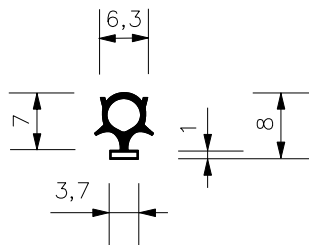

Art. 067

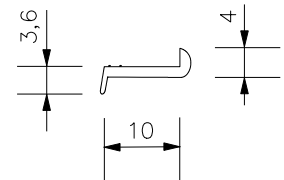

Art. 068

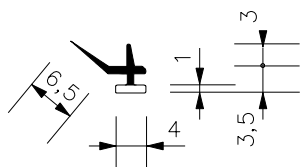

Art. 070

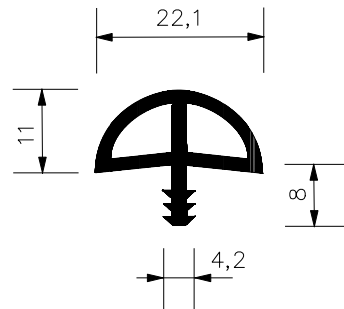

Art. 071

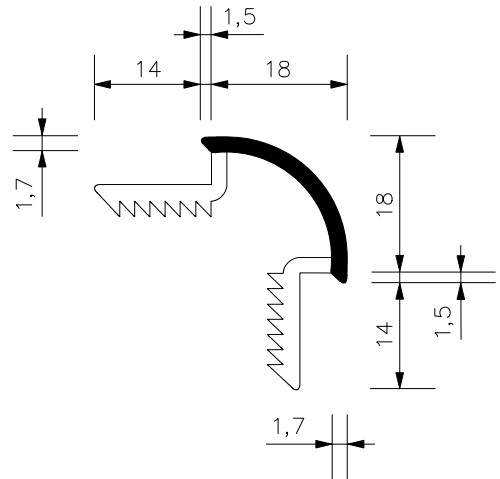

Art. 072

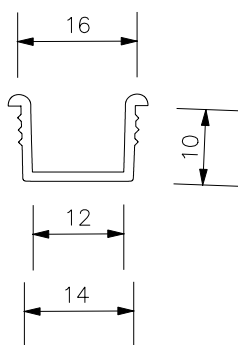

Art. 073

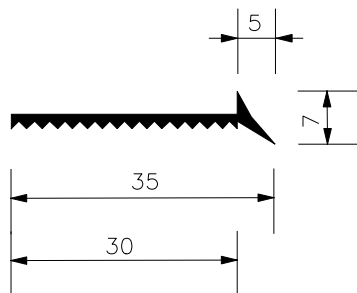

Art. 074

■ FLESSIBILE FLEXIBLE 1 □ FLESSIBILE FLEXIBLE 2 □ RIGIDO RIGID ▣ ESPANSO EXPANDED

▶ A termini di legge, ci riserviamo la proprietà di questi disegni con il divieto di riprodurli e di cederli a terzi senza la nostra autorizzazione.

▶ We reserve all rights on the property of these drawings with warning not to reproduce or to deliver to other parties without our authorization.

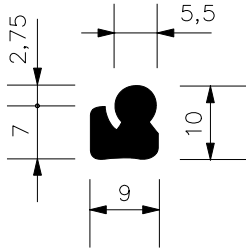

Art. 075

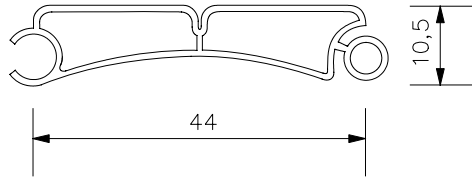

Art. 076

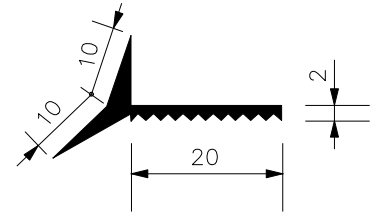

Art. 079

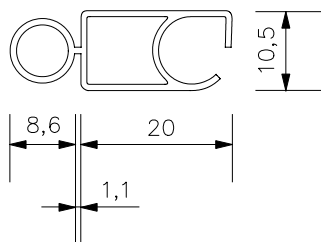

Art. 078

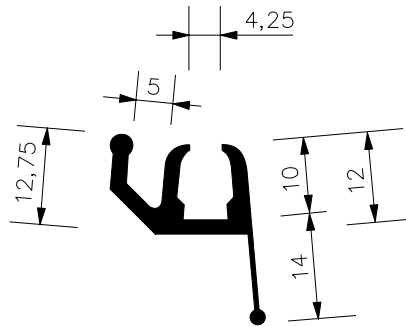

Art. 080

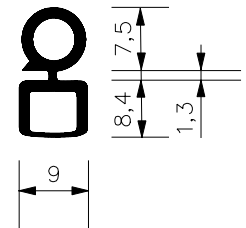

Art. 077

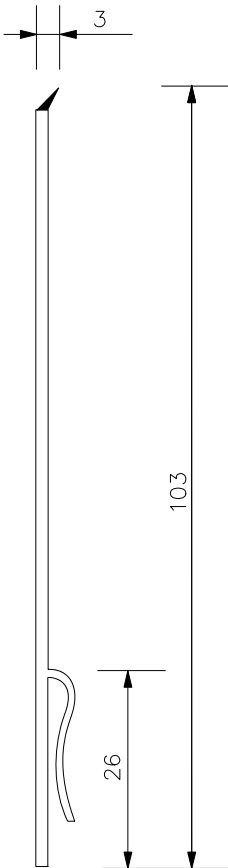

Art. 083

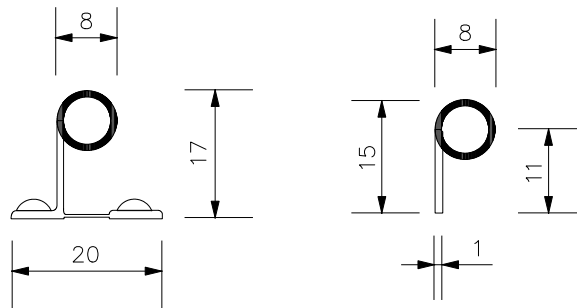

Art. 081

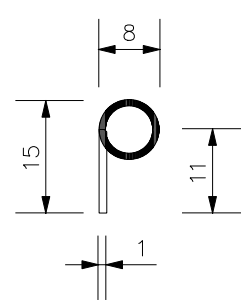

Art. 082

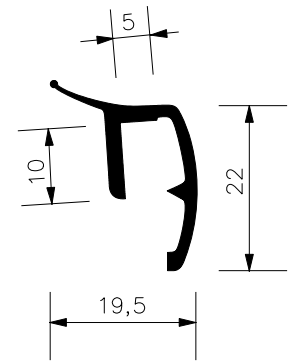

Art. 084

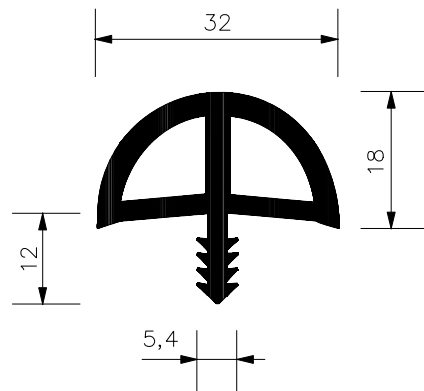

Art. 085

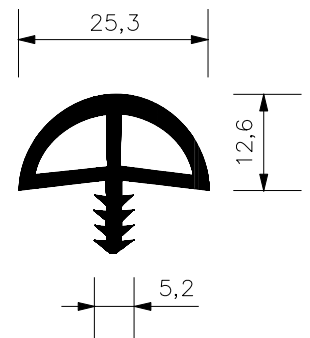

Art. 086

■ FLESSIBILE FLEXIBLE 1 □ FLESSIBILE FLEXIBLE 2 □ RIGIDO RIGID ▨ ESPANSO EXPANDED

▶ A termini di legge, ci riserviamo la proprietà di questi disegni con il divieto di riprodurli e di cederli a terzi senza la nostra autorizzazione.

▶ We reserve all rights on the property of these drawings with warning not to reproduce or to deliver to other parties without our authorization.

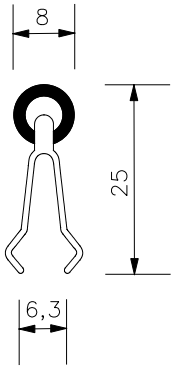

Art. 087

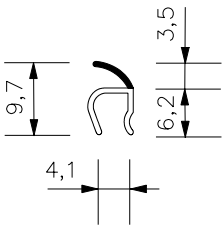

Art. 088

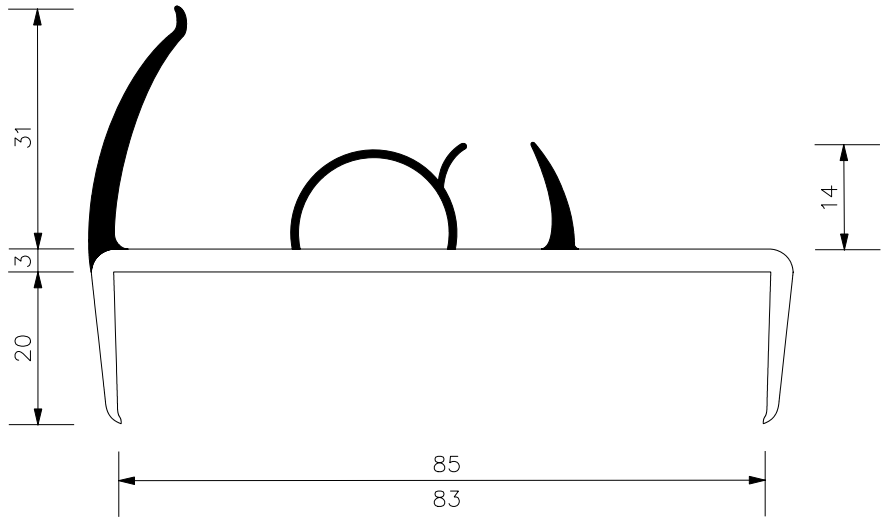

Art. 090

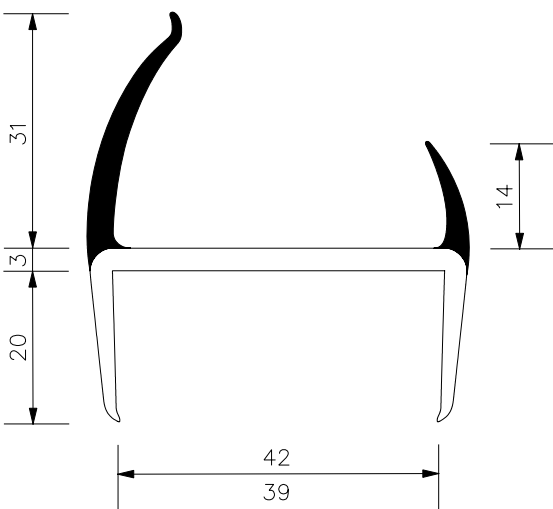

Art. 089

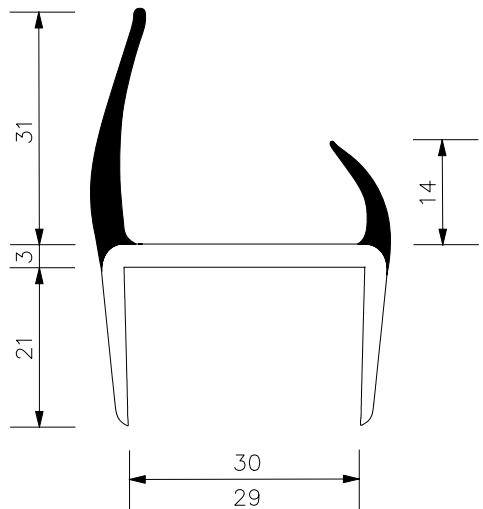

Art. 091

FLESSIBILE *FLEXIBLE 1*
 FLESSIBILE *FLEXIBLE 2*
 RIGIDO *RIGID*
 ESPANSO *EXPANDED*

▶ A termini di legge, ci riserviamo la proprietà di questi disegni con il divieto di riprodurli e di cederli a terzi senza la nostra autorizzazione.

▶ We reserve all rights on the property of these drawings with warning not to reproduce or to deliver to other parties without our authorization.

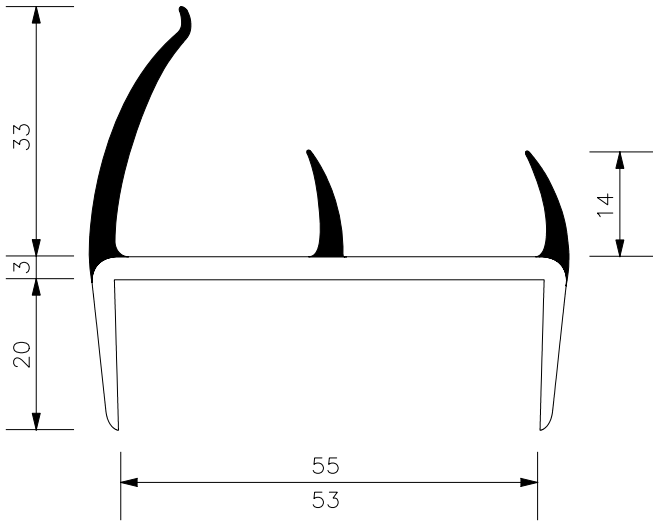

Art. 092

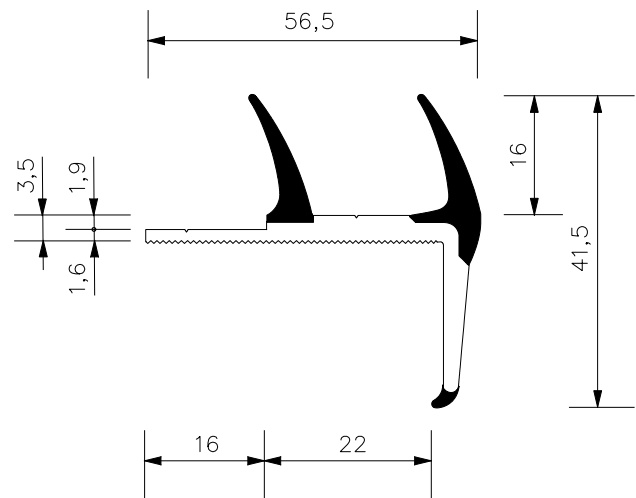

Art. 094

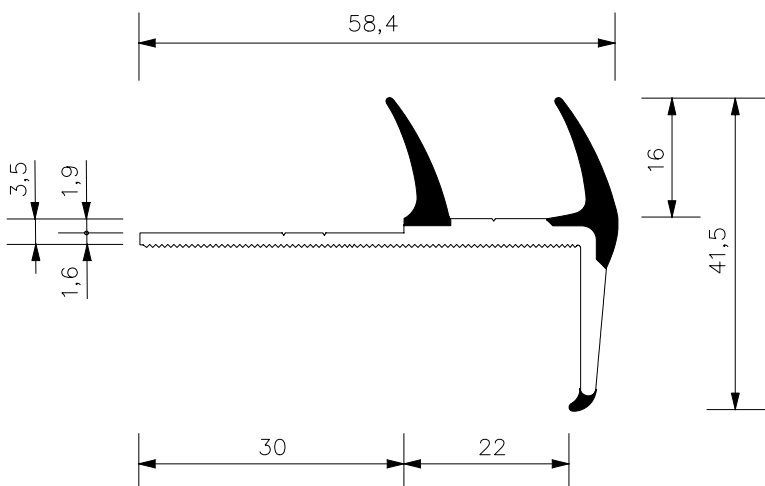

Art. 093

FLESSIBILE *FLEXIBLE 1*
 FLESSIBILE *FLEXIBLE 2*
 RIGIDO *RIGID*
 ESPANSO *EXPANDED*

▶ A termini di legge, ci riserviamo la proprietà di questi disegni con il divieto di riprodurli e di cederli a terzi senza la nostra autorizzazione.

▶ We reserve all rights on the property of these drawings with warning not to reproduce or to deliver to other parties without our authorization.

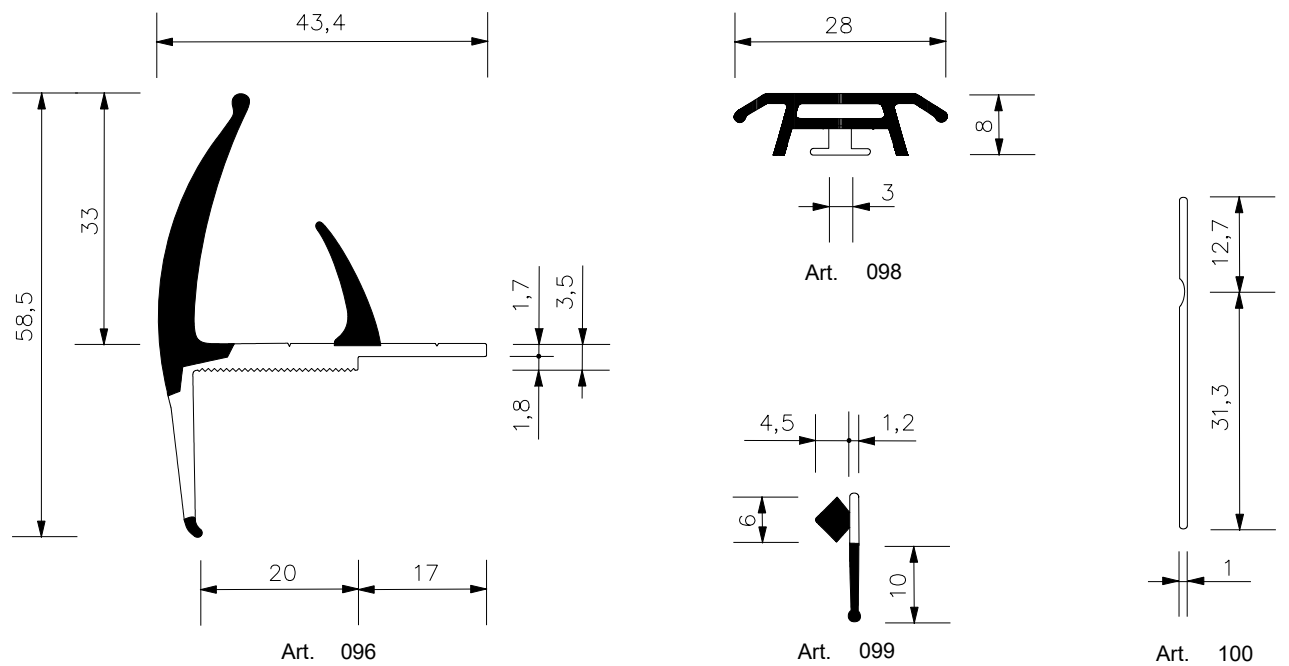
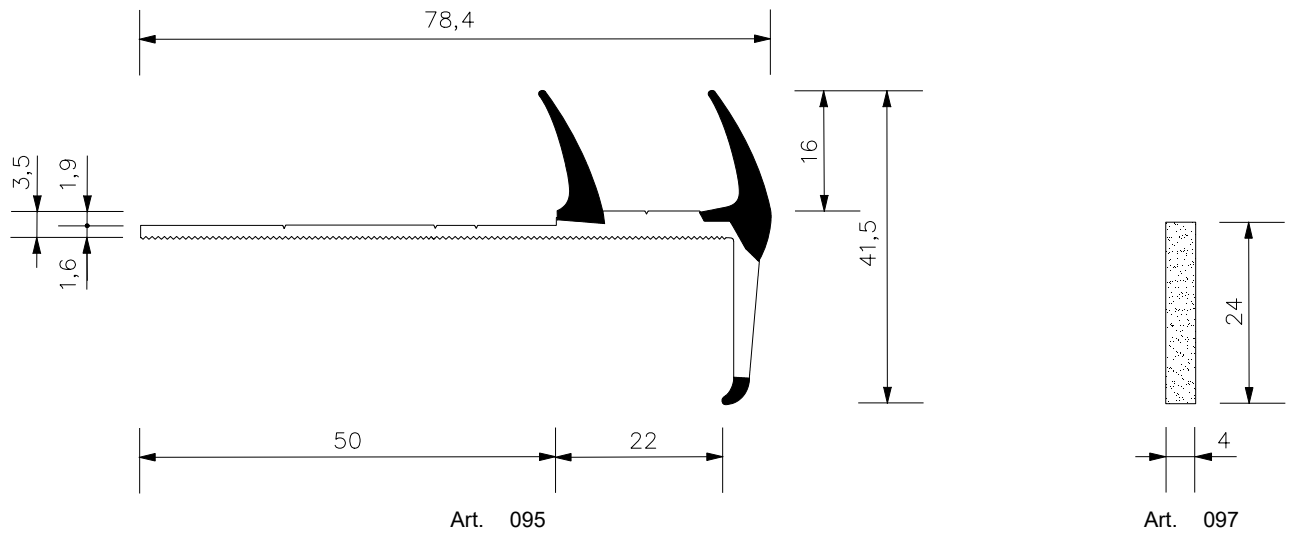

■ FLESSIBILE *FLEXIBLE 1* □ FLESSIBILE *FLEXIBLE 2* □ RIGIDO *RIGID* ▨ ESPANSO *EXPANDED*

▶ A termini di legge, ci riserviamo la proprietà di questi disegni con il divieto di riprodurli e di cederli a terzi senza la nostra autorizzazione.

▶ We reserve all rights on the property of these drawings with warning not to reproduce or to deliver to other parties without our authorization.

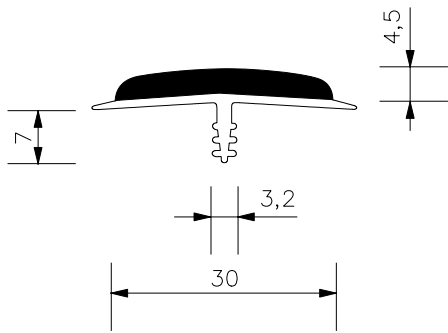

Art. 101

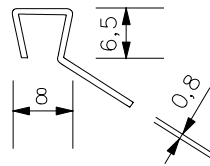

Art. 102

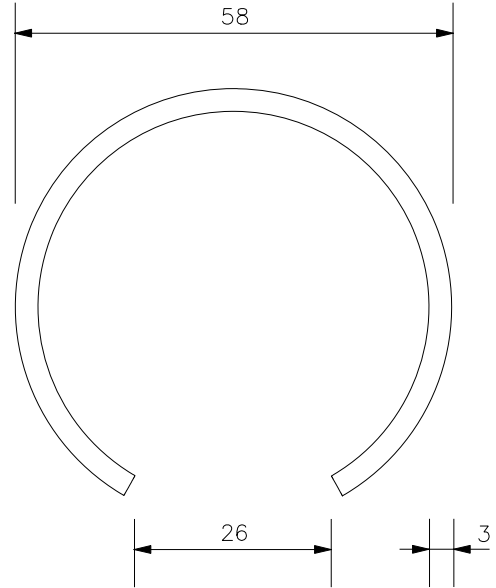

Art. 103

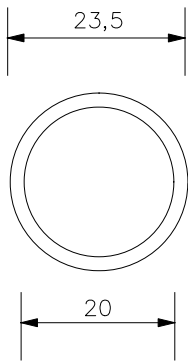

Art. 104

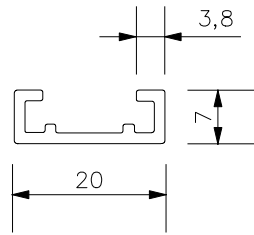

Art. 105

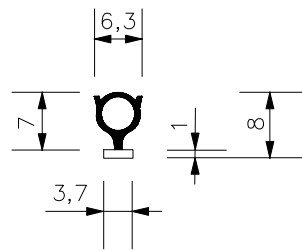

Art. 106

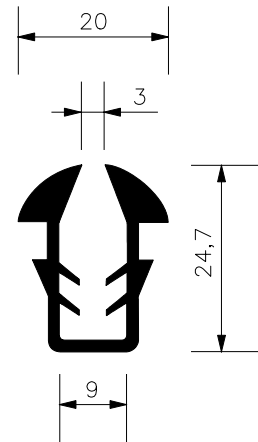

Art. 107

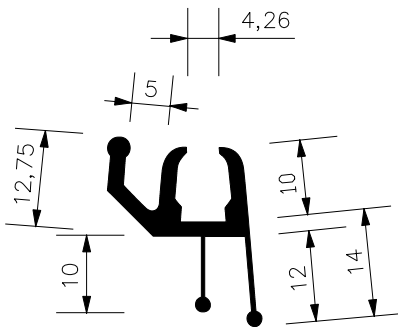

Art. 108

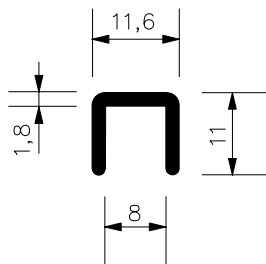

Art. 109

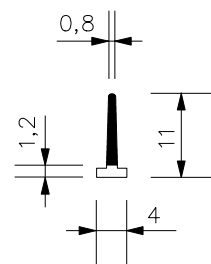

Art. 110

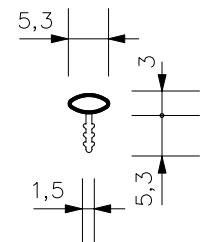

Art. 111

■ FLESSIBILE FLEXIBLE 1 □ FLESSIBILE FLEXIBLE 2 □ RIGIDO RIGID ▣ ESPANSO EXPANDED

▶ A termini di legge, ci riserviamo la proprietà di questi disegni con il divieto di riprodurli e di cederli a terzi senza la nostra autorizzazione.

▶ We reserve all rights on the property of these drawings with warning not to reproduce or to deliver to other parties without our authorization.

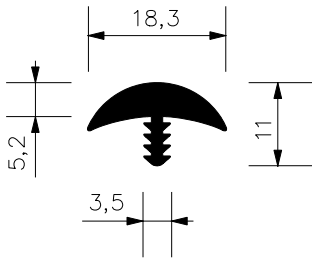

Art. 112-18

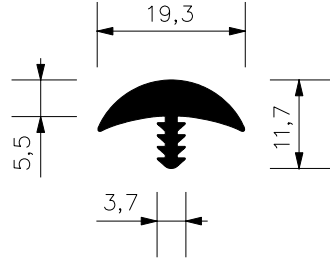

Art. 112-19

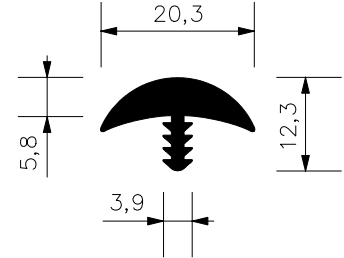

Art. 112-20

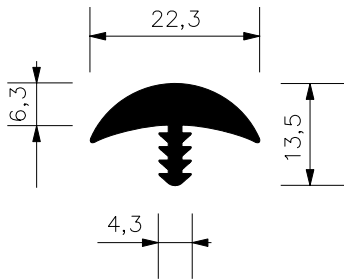

Art. 112-22

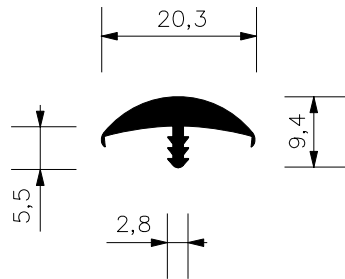

Art. 113-20

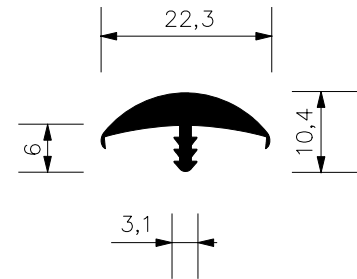

Art. 113-22

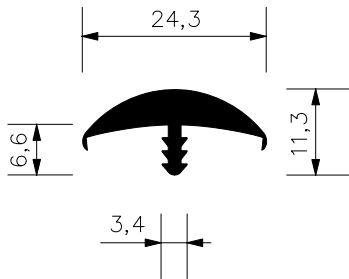

Art. 113-24

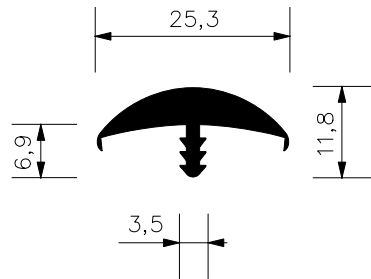

Art. 113-25

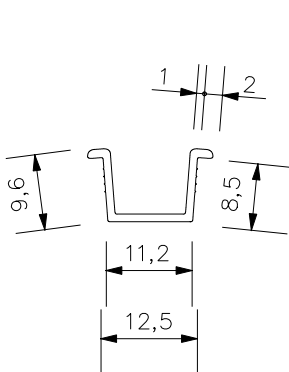

Art. 114

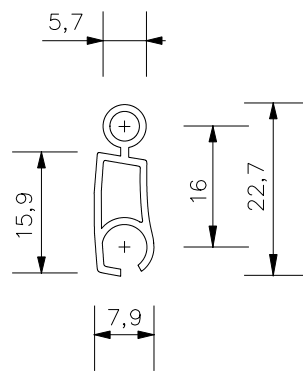

Art. 115

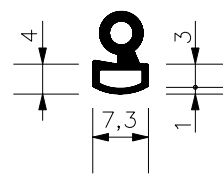

Art. 116

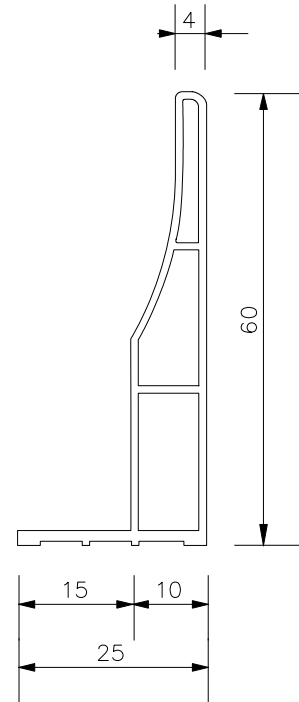

Art. 117

■ FLESSIBILE FLEXIBLE 1 □ FLESSIBILE FLEXIBLE 2 □ RIGIDO RIGID ▣ ESPANSO EXPANDED

▶ A termini di legge, ci riserviamo la proprietà di questi disegni con il divieto di riprodurli e di cederli a terzi senza la nostra autorizzazione.

▶ We reserve all rights on the property of these drawings with warning not to reproduce or to deliver to other parties without our authorization.

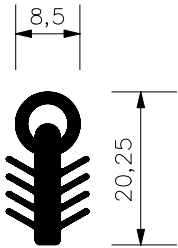

Art. 118

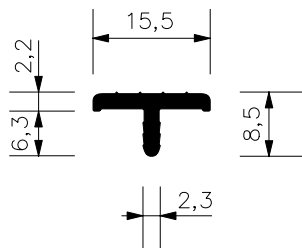

Art. 119

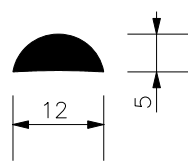

Art. 120

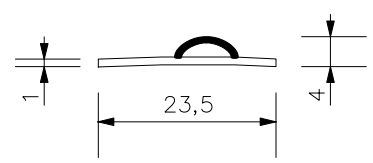

Art. 121

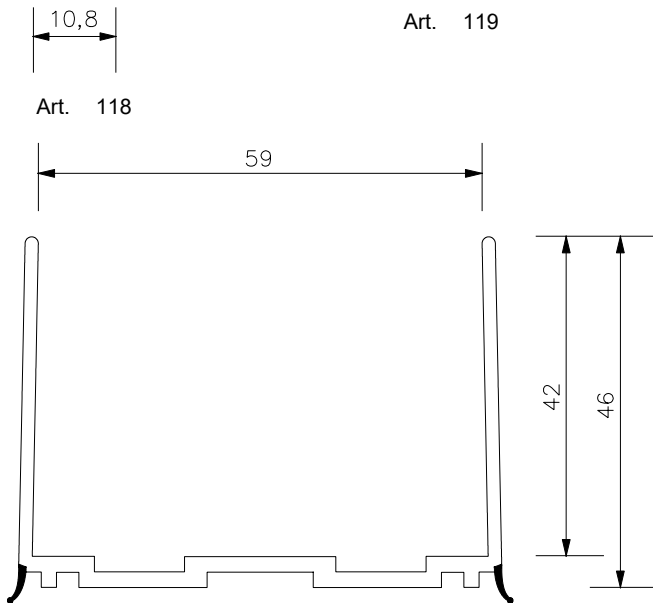

Art. 122

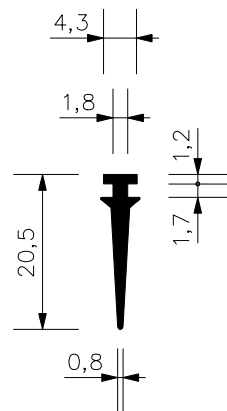

Art. 126

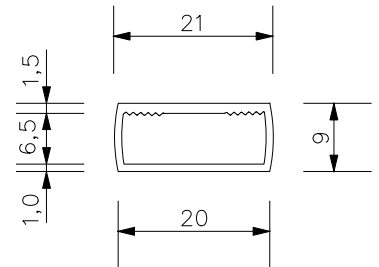

Art. 127

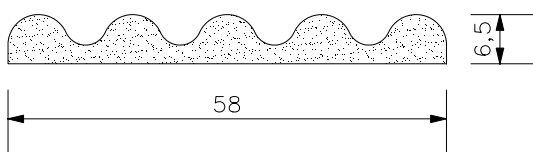

Art. 123

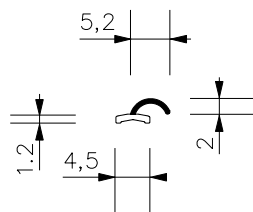

Art. 125

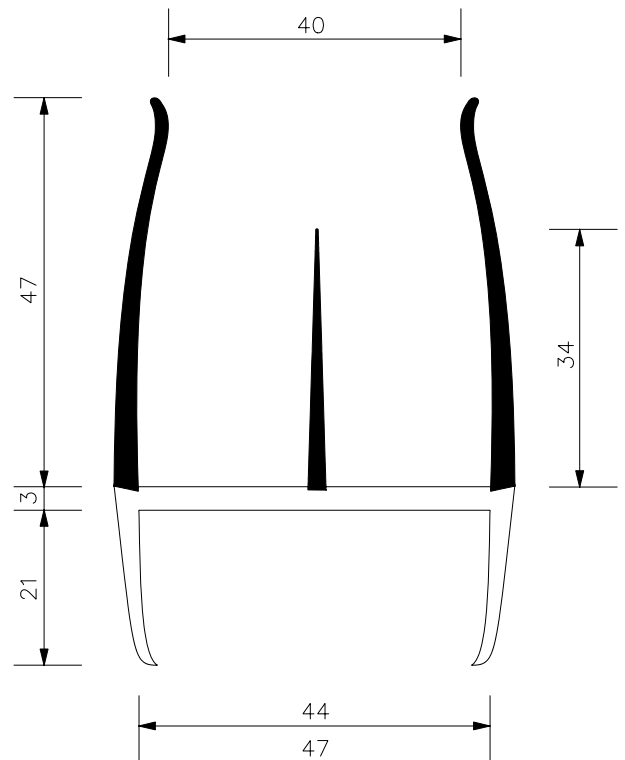

Art. 128

■ FLESSIBILE *FLEXIBLE 1* □ FLESSIBILE *FLEXIBLE 2* □ RIGIDO *RIGID* ▣ ESPANSO *EXPANDED*

▶ A termini di legge, ci riserviamo la proprietà di questi disegni con il divieto di riprodurli e di cederli a terzi senza la nostra autorizzazione.

▶ We reserve all rights on the property of these drawings with warning not to reproduce or to deliver to other parties without our authorization.

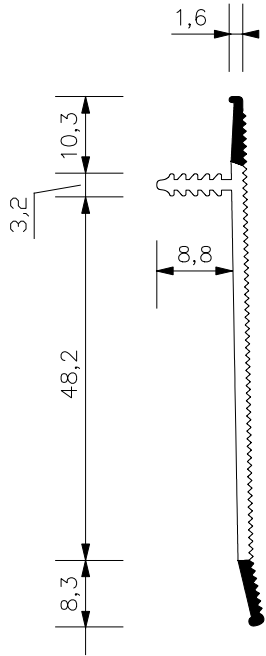

Art. 129

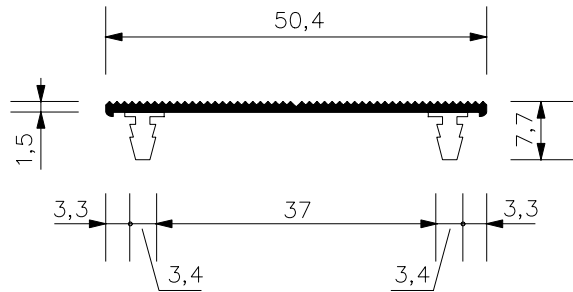

Art. 130

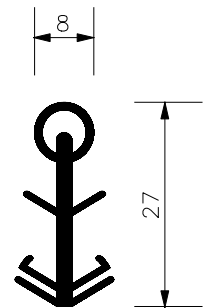

Art. 134

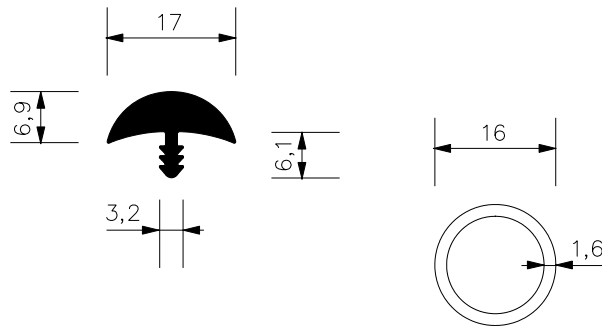

Art. 131

Art. 132

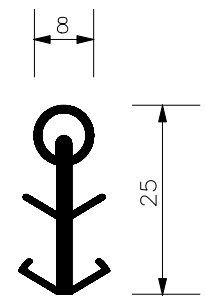

Art. 135

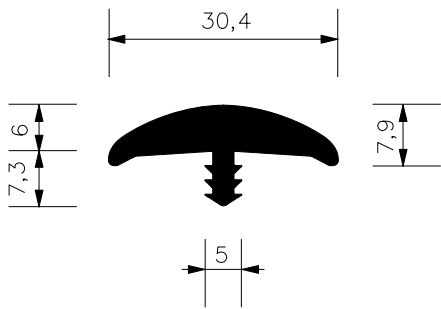

Art. 133

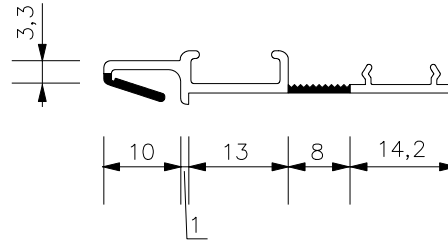

Art. 137

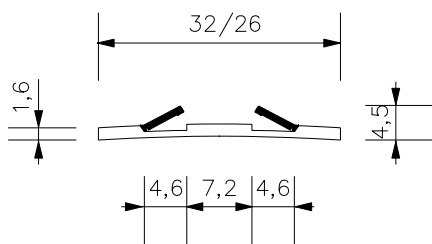

Art. 138

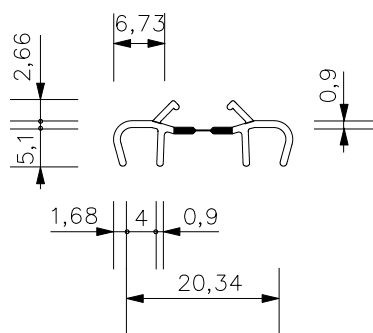

Art. 136

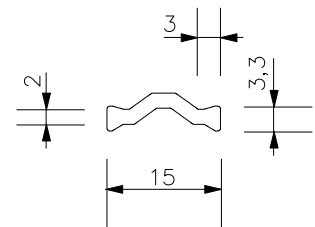

Art. 139

■ FLESSIBILE FLEXIBLE 1 □ FLESSIBILE FLEXIBLE 2 □ RIGIDO RIGID ▣ ESPANSO EXPANDED

▶ A termini di legge, ci riserviamo la proprietà di questi disegni con il divieto di riprodurli e di cederli a terzi senza la nostra autorizzazione.

▶ We reserve all rights on the property of these drawings with warning not to reproduce or to deliver to other parties without our authorization.

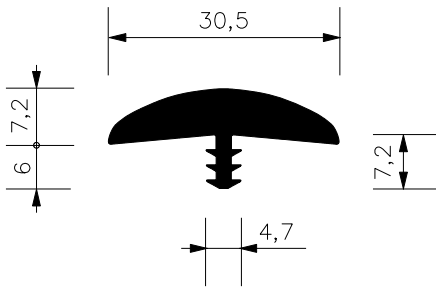

Art. 140

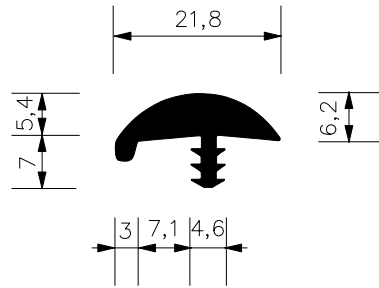

Art. 141

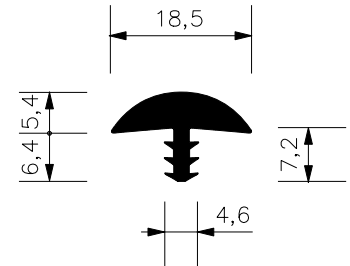

Art. 142

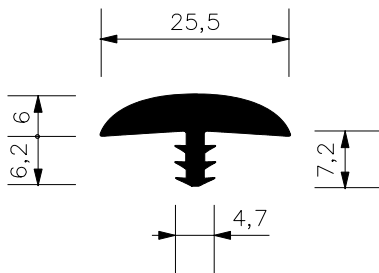

Art. 143

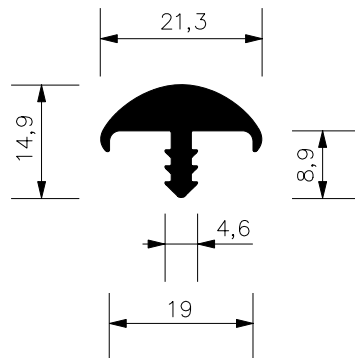

Art. 144

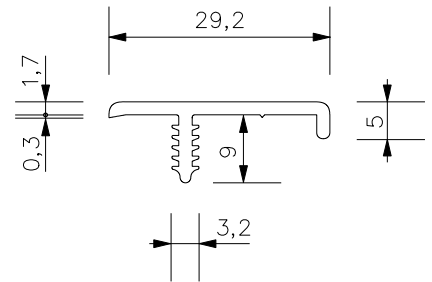

Art. 145

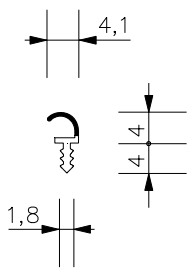

Art. 146

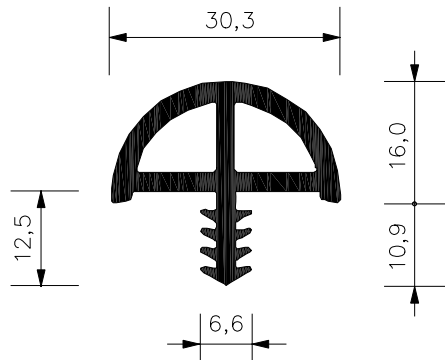

Art. 147

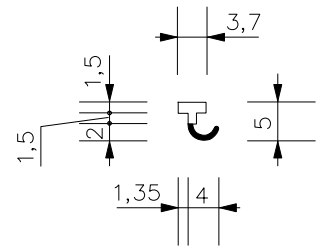

Art. 148

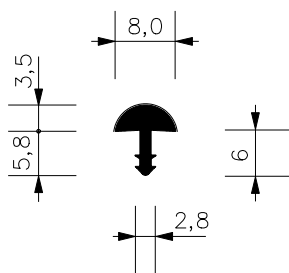

Art. 149

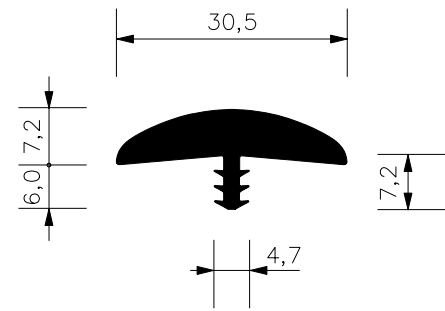

Art. 150

■ FLESSIBILE FLEXIBLE 1 □ FLESSIBILE FLEXIBLE 2 □ RIGIDO RIGID ▣ ESPANSO EXPANDED

▶ A termini di legge, ci riserviamo la proprietà di questi disegni con il divieto di riprodurli e di cederli a terzi senza la nostra autorizzazione.

▶ We reserve all rights on the property of these drawings with warning not to reproduce or to deliver to other parties without our authorization.

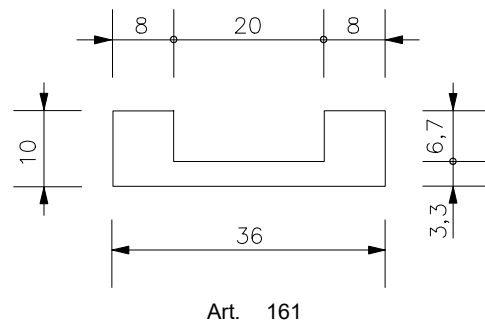
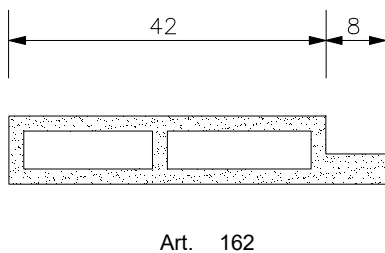
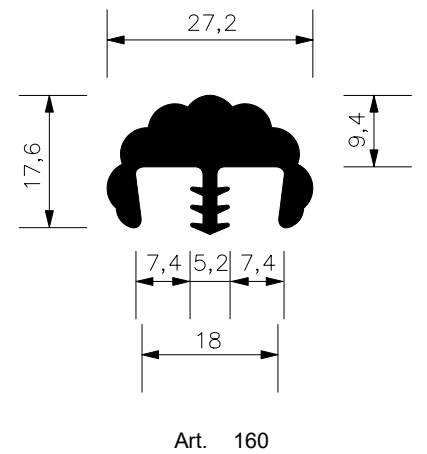
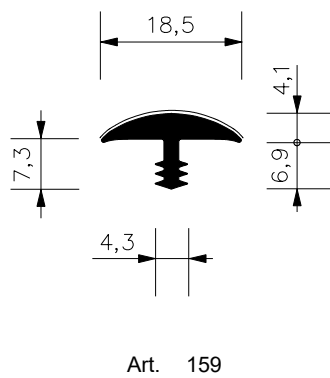
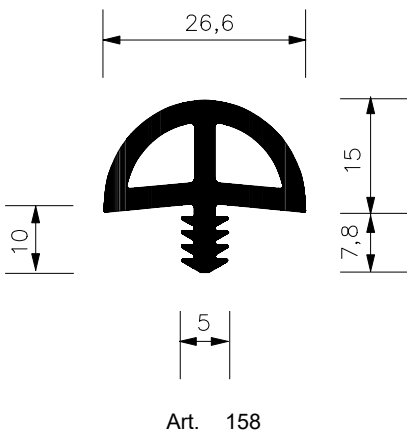
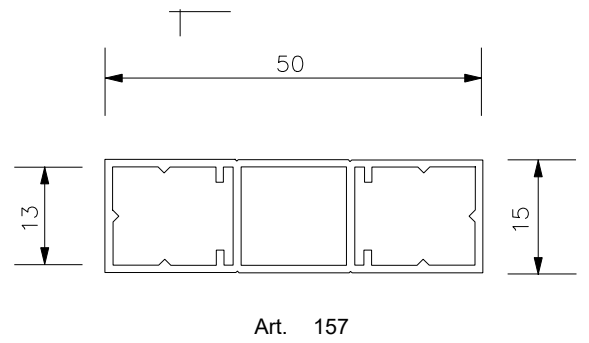
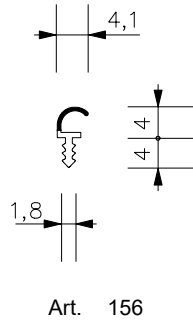
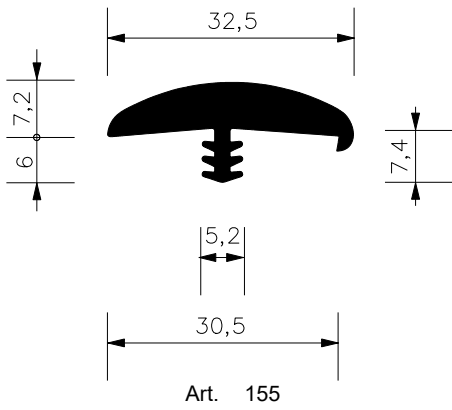
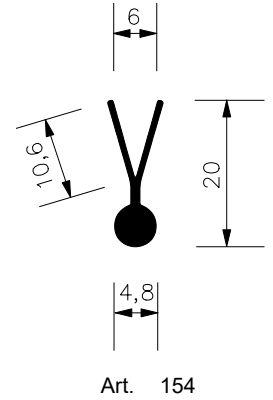
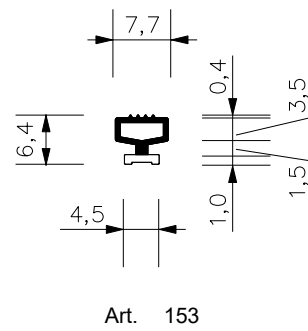
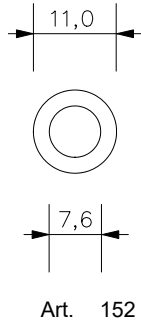
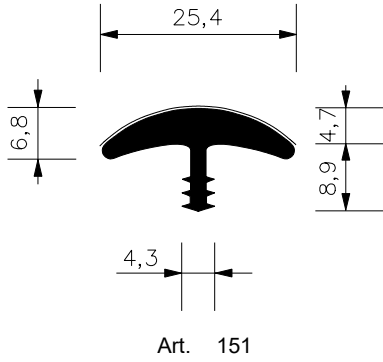

■ FLESSIBILE FLEXIBLE 1 □ FLESSIBILE FLEXIBLE 2 □ RIGIDO RIGID ▣ ESPANSO EXPANDED

▶ A termini di legge, ci riserviamo la proprietà di questi disegni con il divieto di riprodurli e di cederli a terzi senza la nostra autorizzazione.

▶ We reserve all rights on the property of these drawings with warning not to reproduce or to deliver to other parties without our authorization.

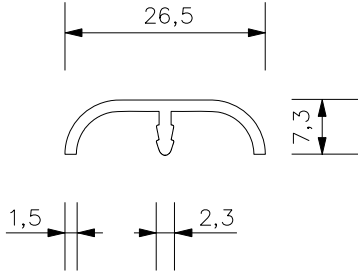

Art. 163

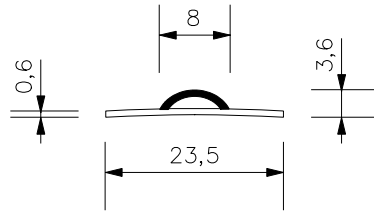

Art. 165

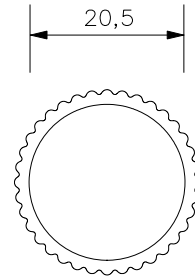

Art. 167

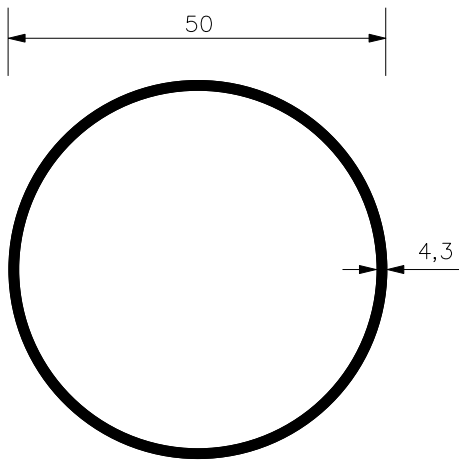

Art. 164

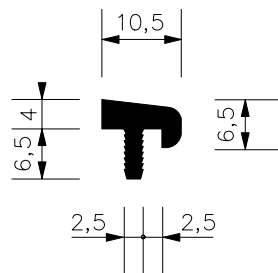

Art. 166

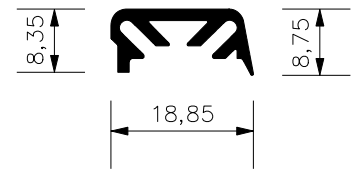

Art. 169

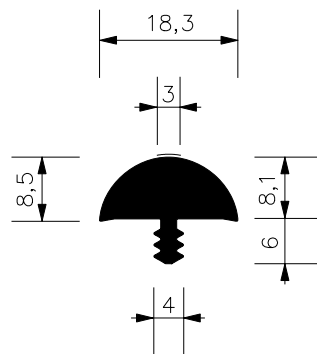

Art. 168

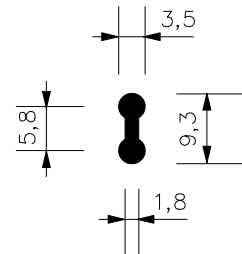

Art. 170

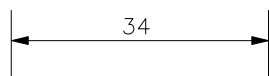

Art. 172

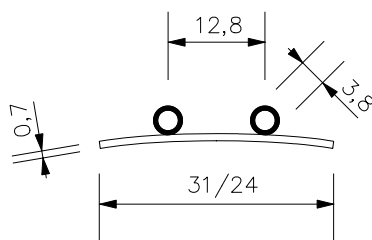

Art. 173

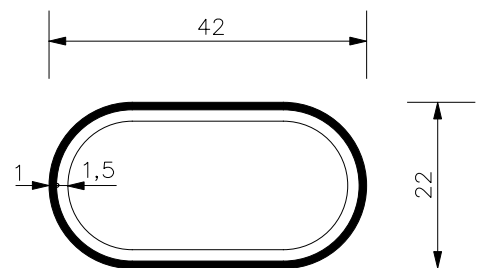

Art. 171

■ FLESSIBILE FLEXIBLE 1 □ FLESSIBILE FLEXIBLE 2 □ RIGIDO RIGID ▣ ESPANSO EXPANDED

▶ A termini di legge, ci riserviamo la proprietà di questi disegni con il divieto di riprodurli e di cederli a terzi senza la nostra autorizzazione.

▶ We reserve all rights on the property of these drawings with warning not to reproduce or to deliver to other parties without our authorization.

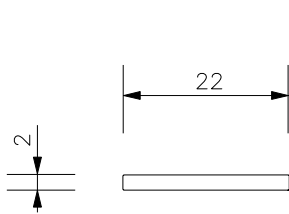

Art. 175

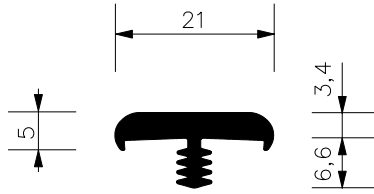

Art. 174

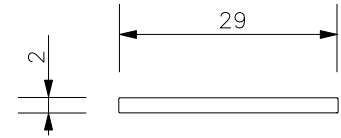

Art. 176

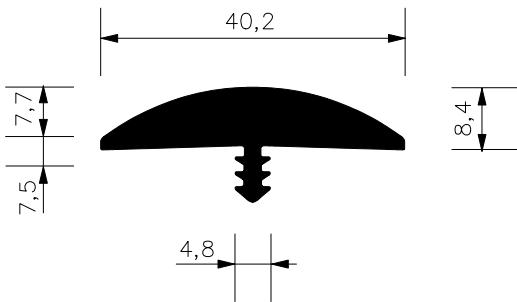

Art. 177

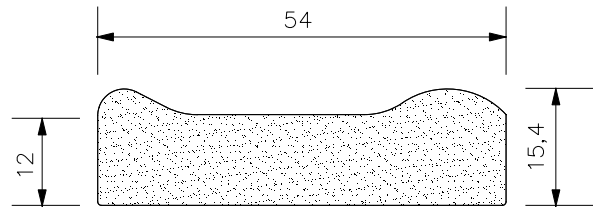

Art. 182

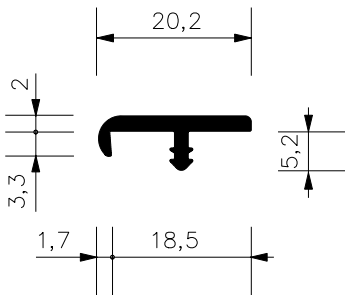

Art. 178

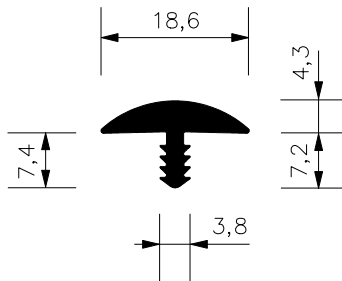

Art. 179

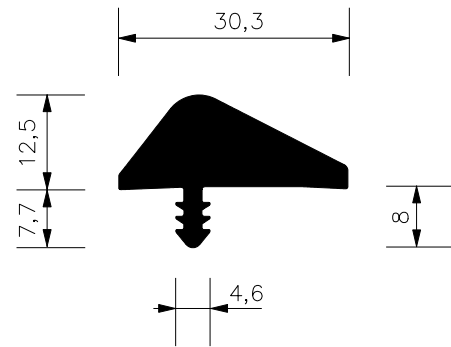

Art. 180

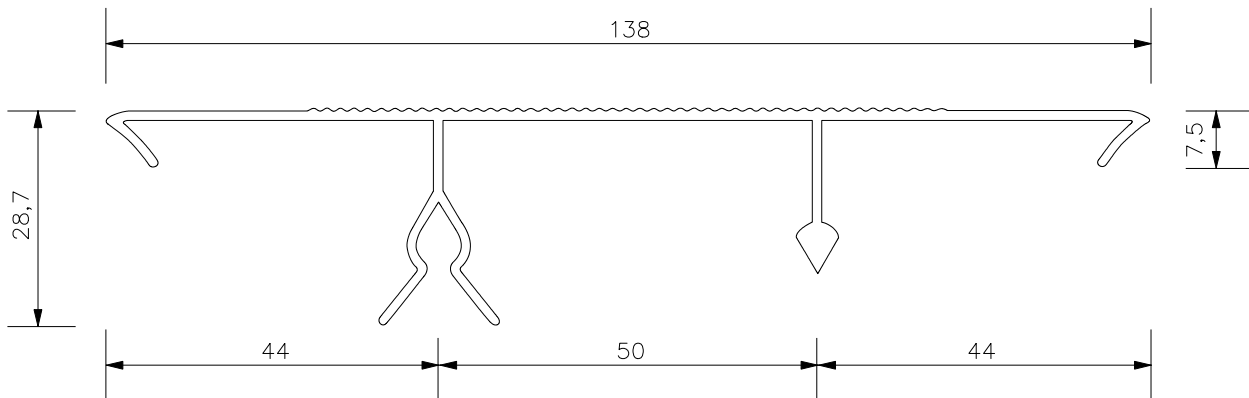

Art. 181

■ FLESSIBILE *FLEXIBLE 1* □ FLESSIBILE *FLEXIBLE 2* □ RIGIDO *RIGID* □ ESPANSO *EXPANDED*

▶ A termini di legge, ci riserviamo la proprietà di questi disegni con il divieto di riprodurli e di cederli a terzi senza la nostra autorizzazione.

▶ We reserve all rights on the property of these drawings with warning not to reproduce or to deliver to other parties without our authorization.

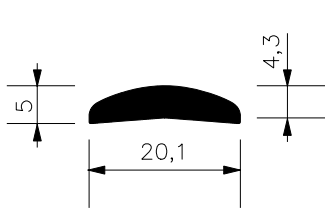

Art. 183

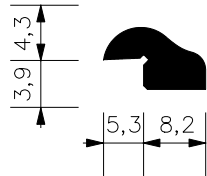

Art. 188

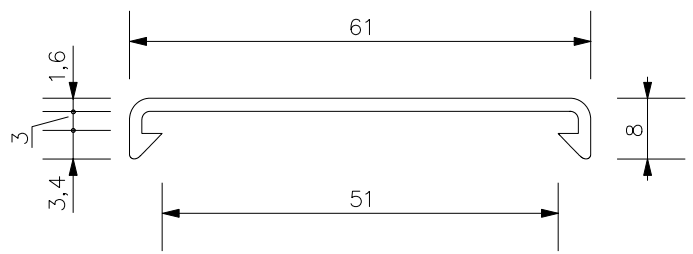

Art. 193

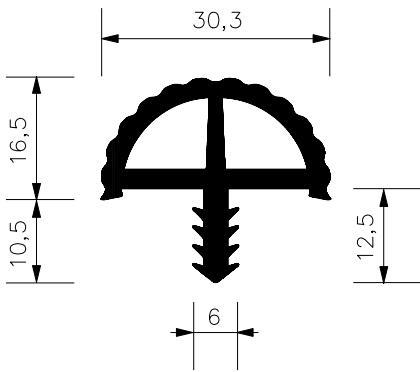

Art. 185

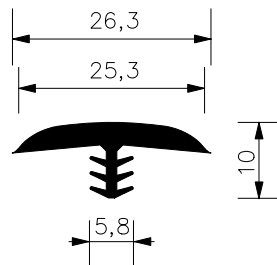

Art. 186

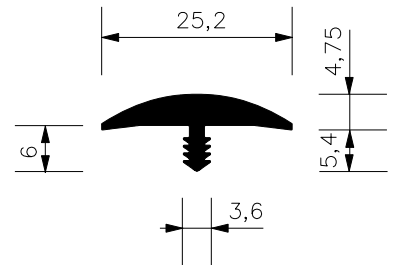

Art. 189

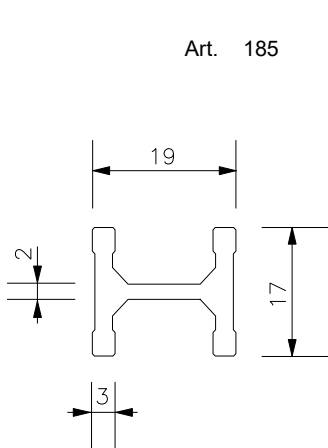

Art. 190

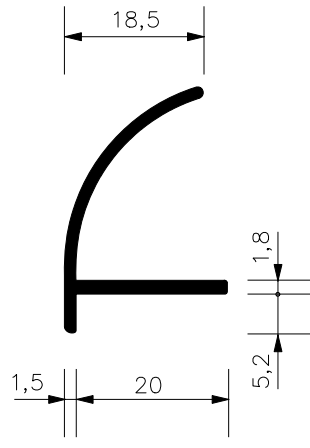

Art. 191

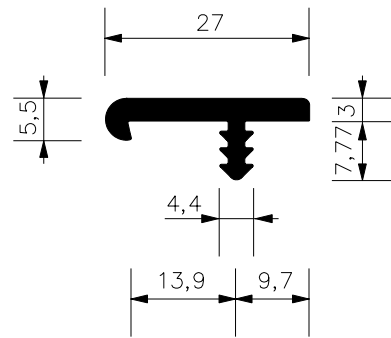

Art. 184

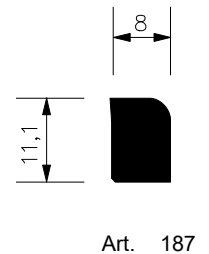

Art. 187

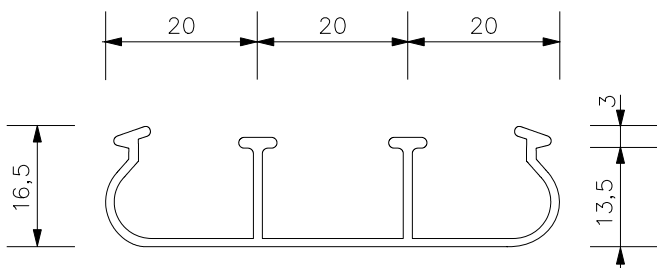

Art. 192

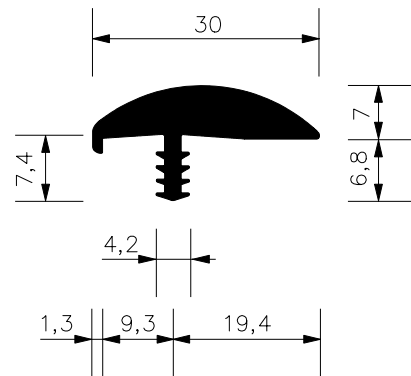

Art. 194

■ FLESSIBILE FLEXIBLE 1 □ FLESSIBILE FLEXIBLE 2 □ RIGIDO RIGID ▣ ESPANSO EXPANDED

▶ A termini di legge, ci riserviamo la proprietà di questi disegni con il divieto di riprodurli e di cederli a terzi senza la nostra autorizzazione.

▶ We reserve all rights on the property of these drawings with warning not to reproduce or to deliver to other parties without our authorization.

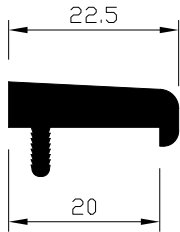

Art. 195

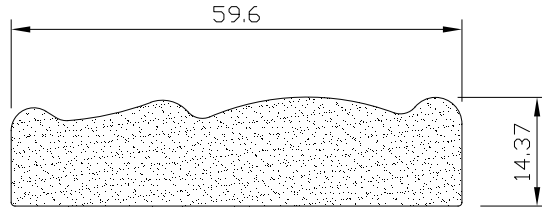

Art. 196

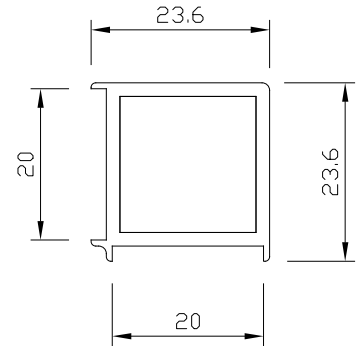

Art. 197

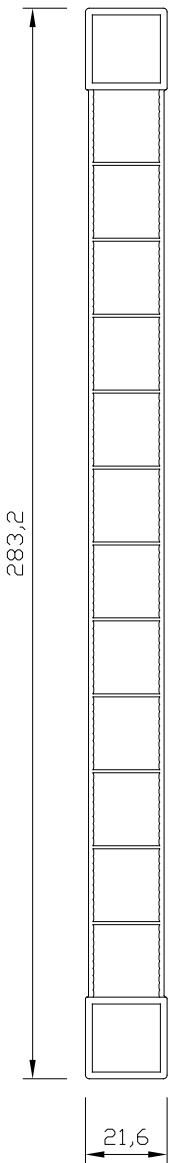

Scala 1:2 Art. 198

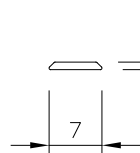

Art. 199

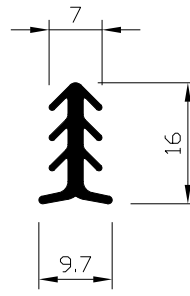

Art. 200

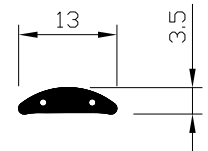

Art. 201

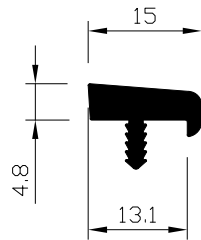

Art. 202

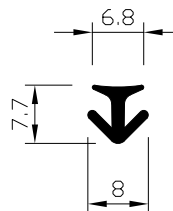

Art. 203

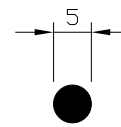

Art. 204

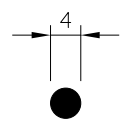

Art. 205

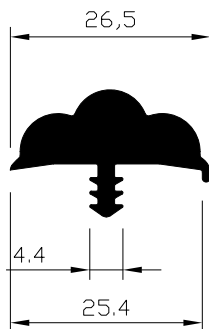

Art. 206

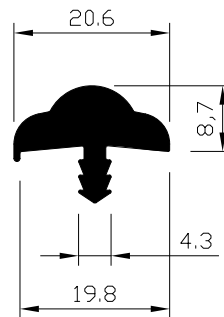

Art. 207

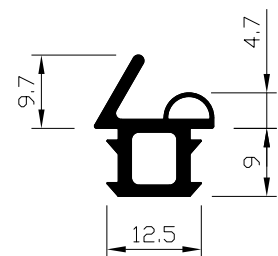

Art. 209

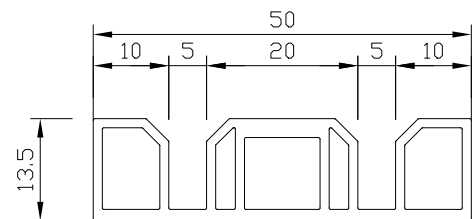

Art. 208

■ FLESSIBILE FLEXIBLE 1 □ FLESSIBILE FLEXIBLE 2 □ RIGIDO RIGID ▣ ESPANSO EXPANDED

▶ A termini di legge, ci riserviamo la proprietà di questi disegni con il divieto di riprodurli e di cederli a terzi senza la nostra autorizzazione.

▶ We reserve all rights on the property of these drawings with warning not to reproduce or to deliver to other parties without our authorization.

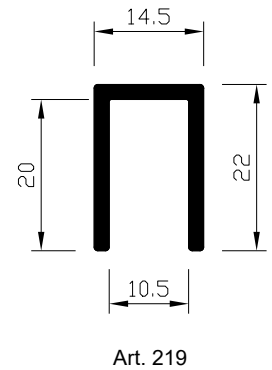
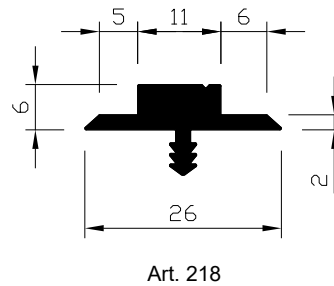
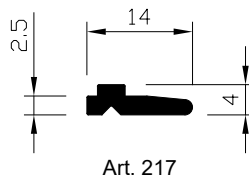
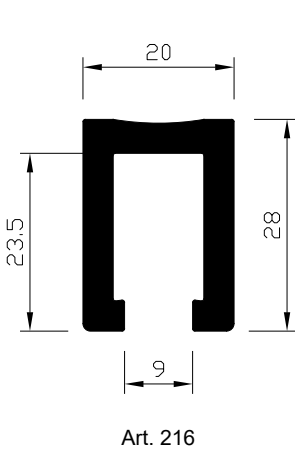
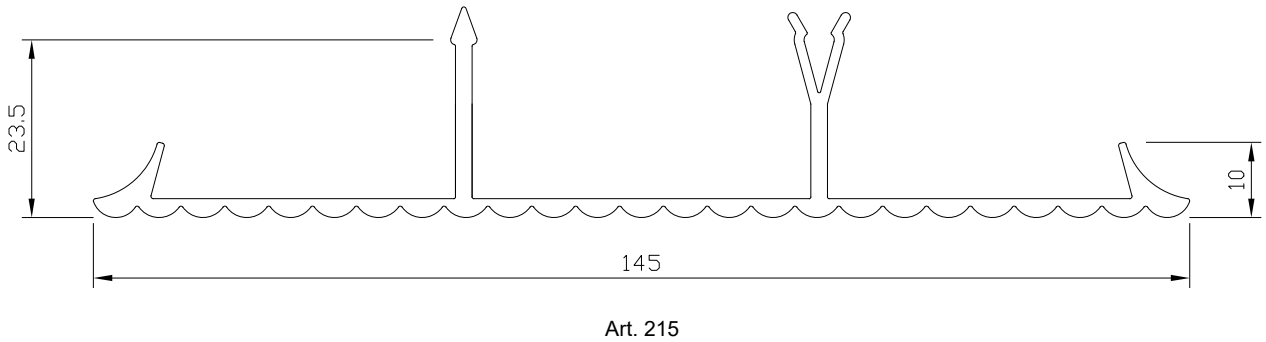
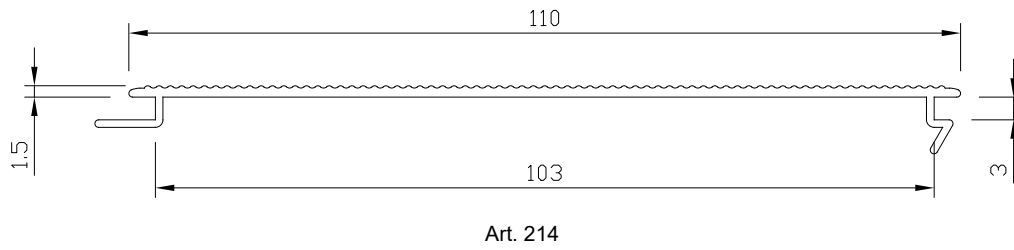
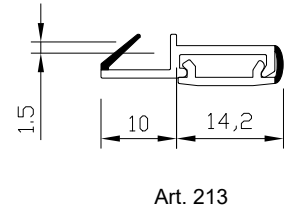
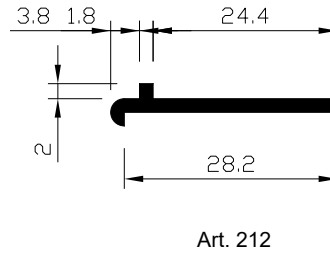
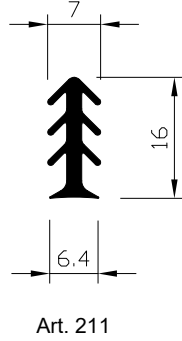
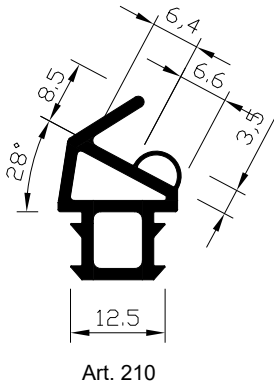

FLESSIBILE *FLEXIBLE 1*
 FLESSIBILE *FLEXIBLE 2*
 RIGIDO *RIGID*
 ESPANSO *EXPANDED*

▶ A termini di legge, ci riserviamo la proprietà di questi disegni con il divieto di riprodurli e di cederli a terzi senza la nostra autorizzazione.

▶ We reserve all rights on the property of these drawings with warning not to reproduce or to deliver to other parties without our authorization.

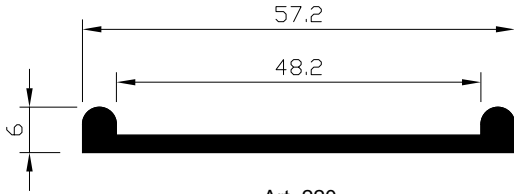

Art. 220

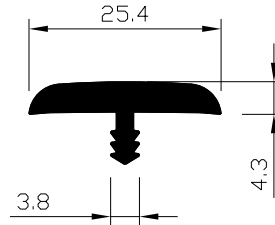

Art. 221

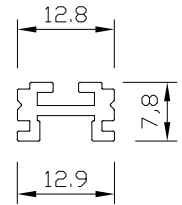

Art. 222

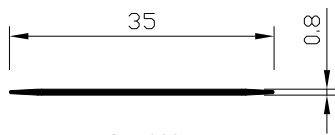

Art. 223

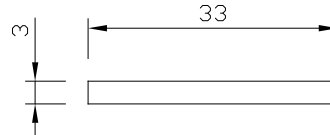

Art. 225

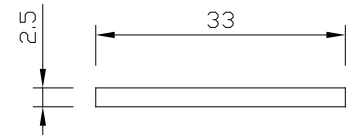

Art. 227

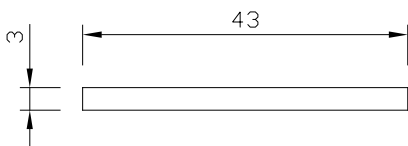

Art. 224

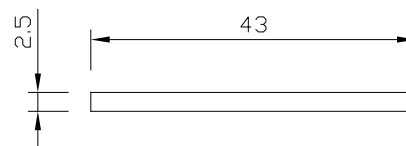

Art. 226

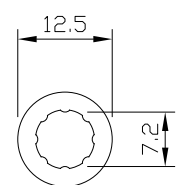

Art. 229

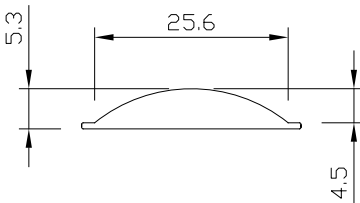

Art. 228

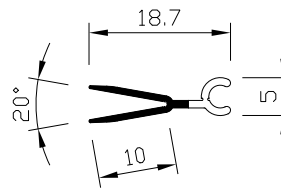

Art. 230

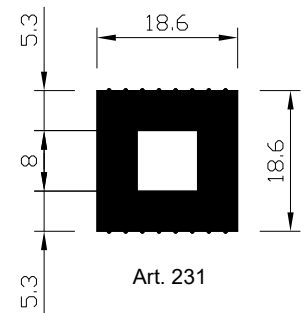

Art. 231

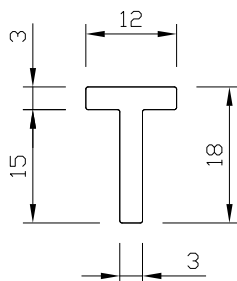

Art. 232

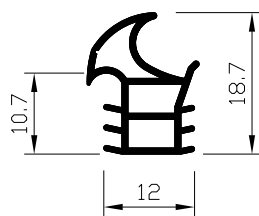

Art. 233

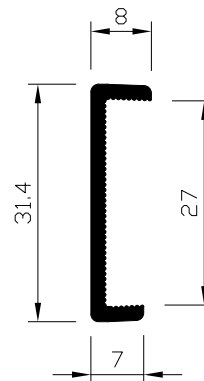

Art. 234

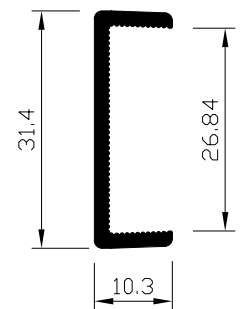

Art. 235

■ FLESSIBILE *FLEXIBLE 1* □ FLESSIBILE *FLEXIBLE 2* □ RIGIDO *RIGID* □ ESPANSO *EXPANDED*

▶ A termini di legge, ci riserviamo la proprietà di questi disegni con il divieto di riprodurli e di cederli a terzi senza la nostra autorizzazione.

▶ We reserve all rights on the property of these drawings with warning not to reproduce or to deliver to other parties without our authorization.

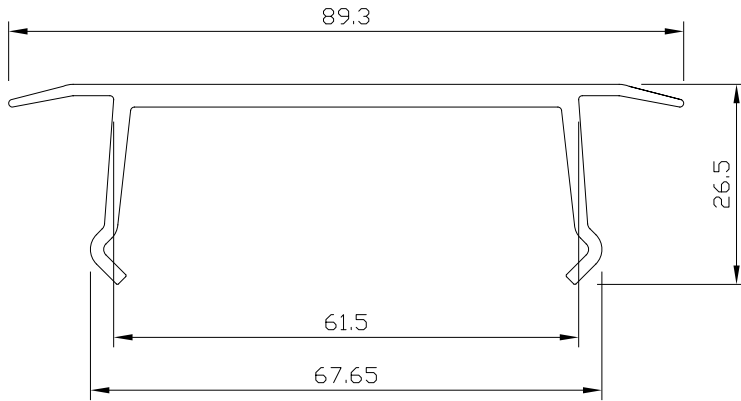

Art. 236

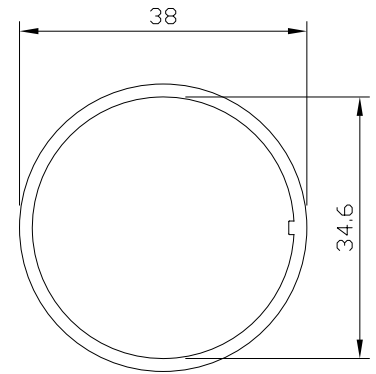

Art. 237

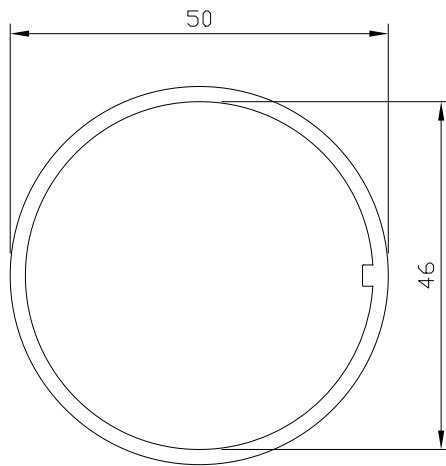

Art. 238

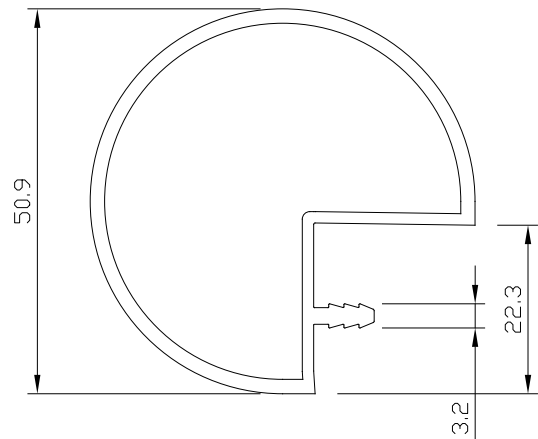

Art. 239

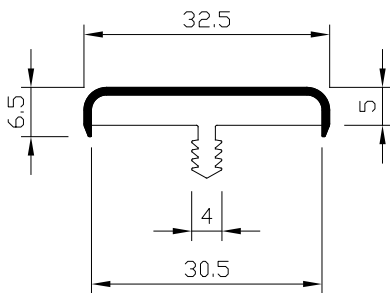

Art. 240

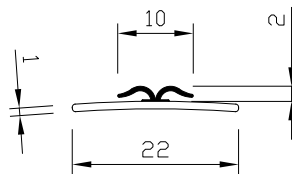

Art. 241

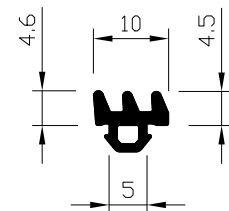

Art. 242

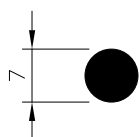

Art. 244

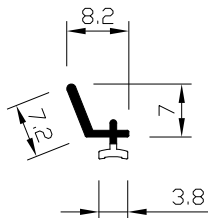

Art. 243

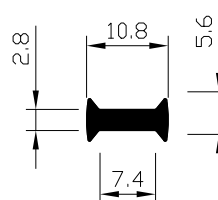

Art. 245

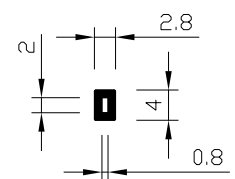

Art. 246

■ FLESSIBILE *FLEXIBLE 1* □ FLESSIBILE *FLEXIBLE 2* □ RIGIDO *RIGID* ▣ ESPANSO *EXPANDED*

▶ A termini di legge, ci riserviamo la proprietà di questi disegni con il divieto di riprodurli e di cederli a terzi senza la nostra autorizzazione.

▶ We reserve all rights on the property of these drawings with warning not to reproduce or to deliver to other parties without our authorization.

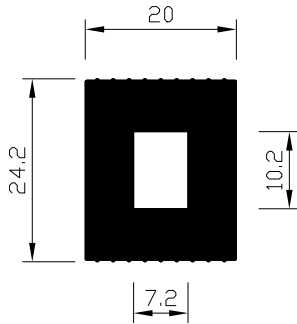

Art. 247

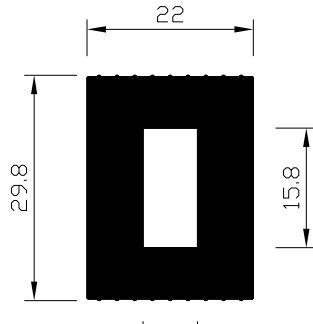

Art. 248



Art. 249

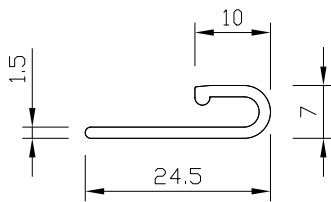

Art. 250

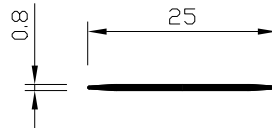

Art. 251

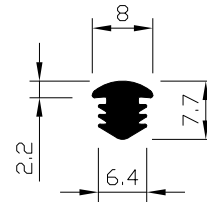

Art. 252

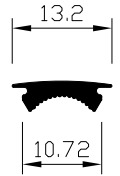

Art. 255

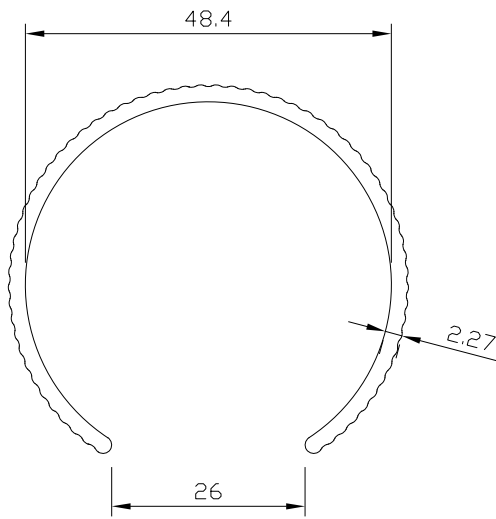

Art. 253

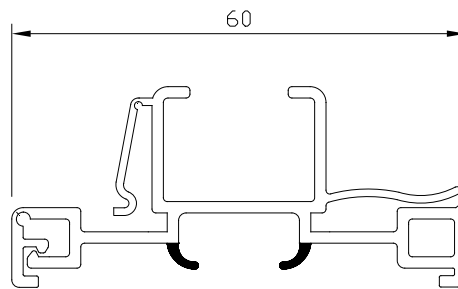

Art. 254

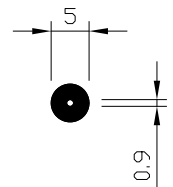

Art. 256

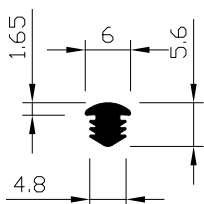

Art. 258

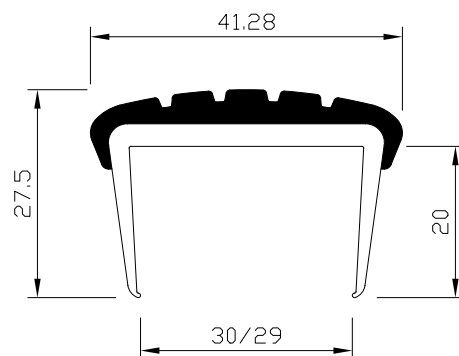

Art. 257

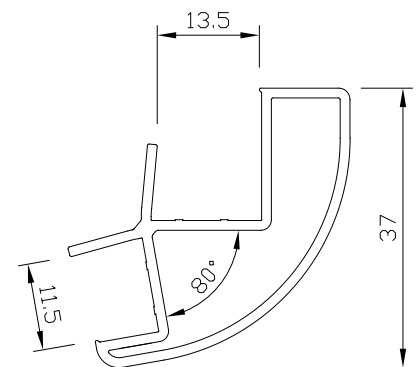

Art. 259

■ FLESSIBILE *FLEXIBLE 1* □ FLESSIBILE *FLEXIBLE 2* □ RIGIDO *RIGID* ▣ ESPANSO *EXPANDED*

▶ A termini di legge, ci riserviamo la proprietà di questi disegni con il divieto di riprodurli e di cederli a terzi senza la nostra autorizzazione.

▶ We reserve all rights on the property of these drawings with warning not to reproduce or to deliver to other parties without our authorization.

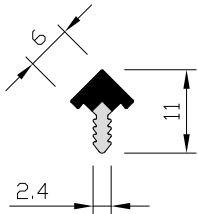

Art. 260

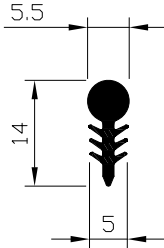

Art. 262

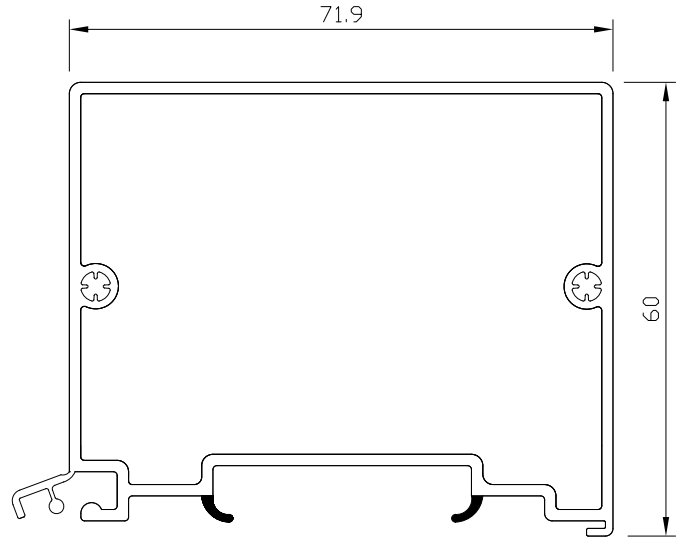

Art. 266

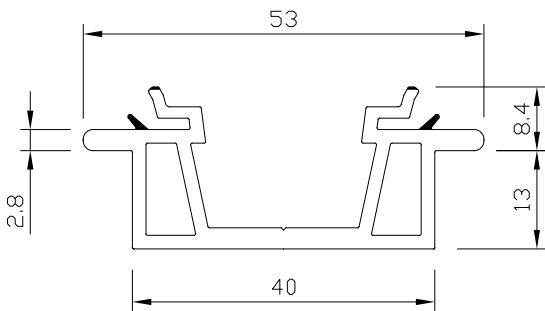

Art. 263

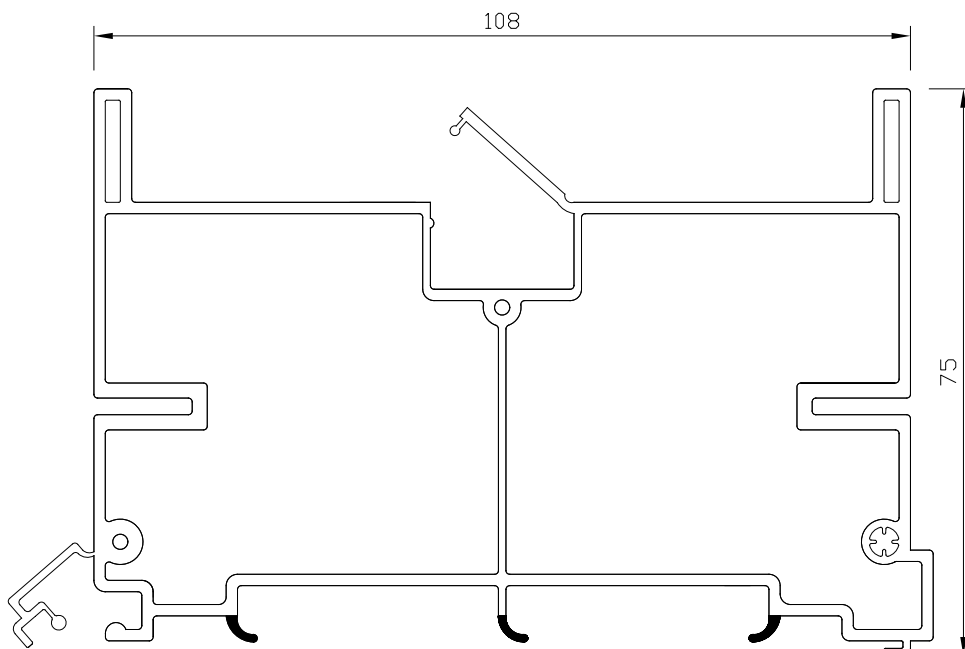

Art. 265

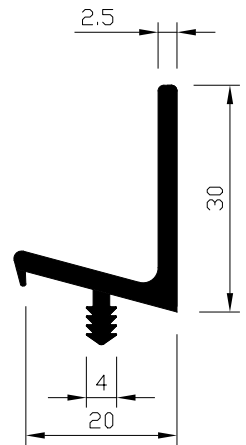

Art. 261

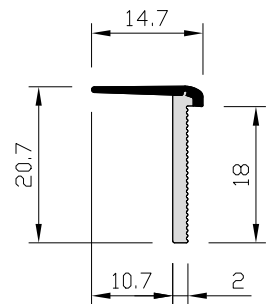

Art. 264

■ FLESSIBILE *FLEXIBLE 1* □ FLESSIBILE *FLEXIBLE 2* □ RIGIDO *RIGID* ▣ ESPANSO *EXPANDED*

▶ A termini di legge, ci riserviamo la proprietà di questi disegni con il divieto di riprodurli e di cederli a terzi senza la nostra autorizzazione.

▶ We reserve all rights on the property of these drawings with warning not to reproduce or to deliver to other parties without our authorization.

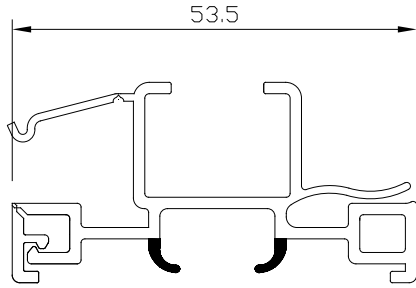

Art. 267

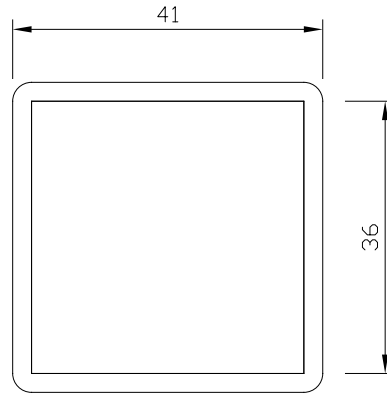

Art. 268

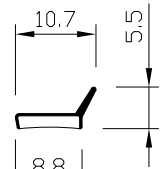

Art. 269

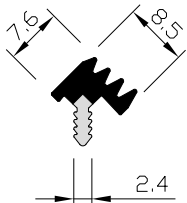

Art. 270

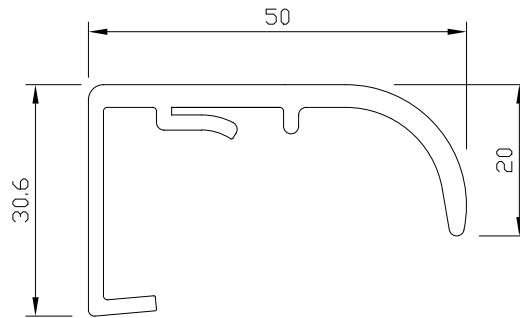

Art. 271

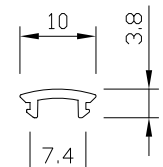

Art. 272

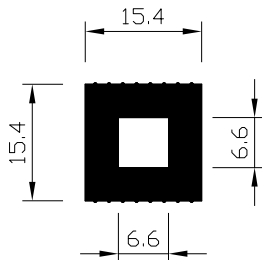

Art. 273

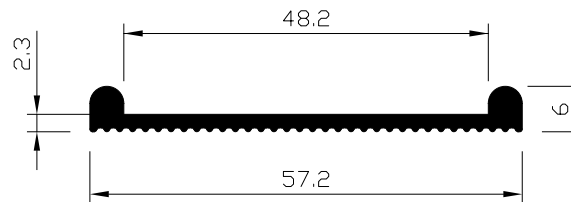

Art. 274

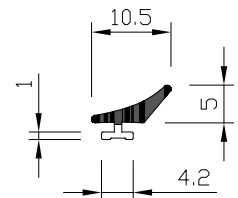

Art. 276

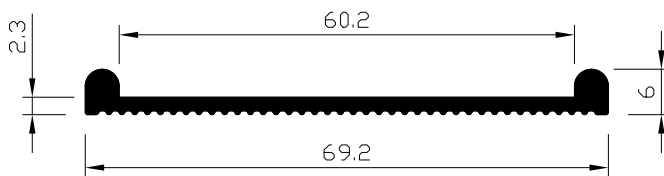

Art. 275

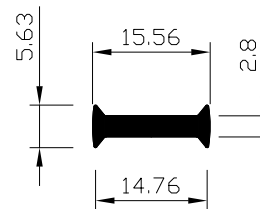

Art. 277

FLESSIBILE *FLEXIBLE 1*
 FLESSIBILE *FLEXIBLE 2*
 RIGIDO *RIGID*
 ESPANSO *EXPANDED*

▶ A termini di legge, ci riserviamo la proprietà di questi disegni con il divieto di riprodurli e di cederli a terzi senza la nostra autorizzazione.

▶ We reserve all rights on the property of these drawings with warning not to reproduce or to deliver to other parties without our authorization.

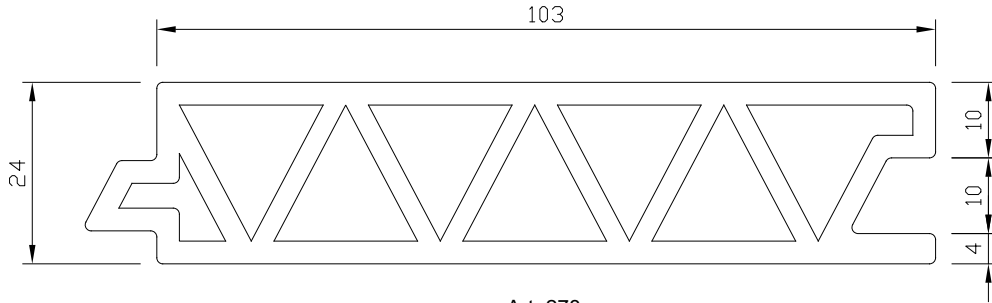

Art. 278

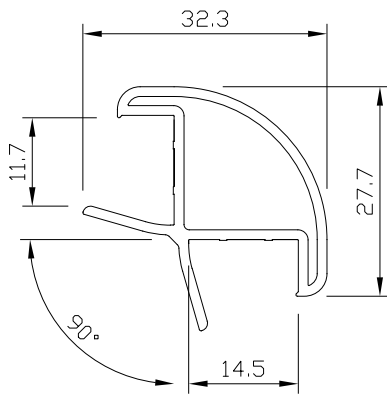

Art. 279

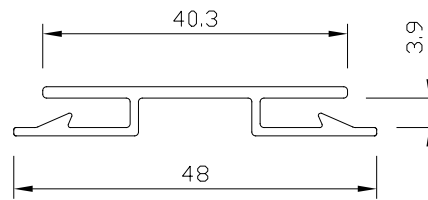

Art. 280

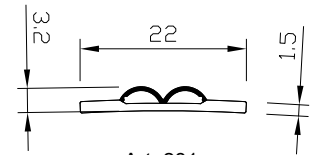

Art. 281

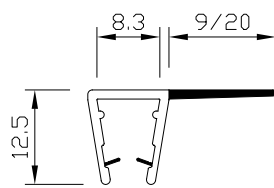

Art. 283

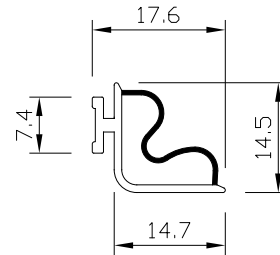

Art. 287

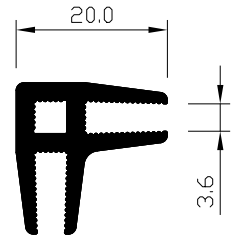

Art. 284

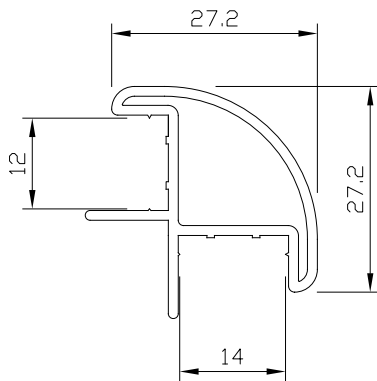

Art. 282

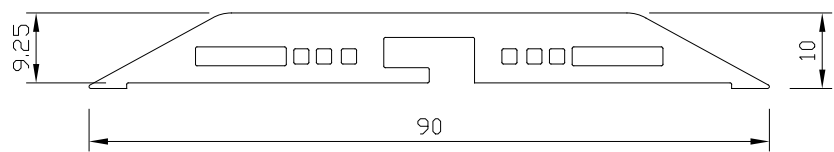

Art. 285

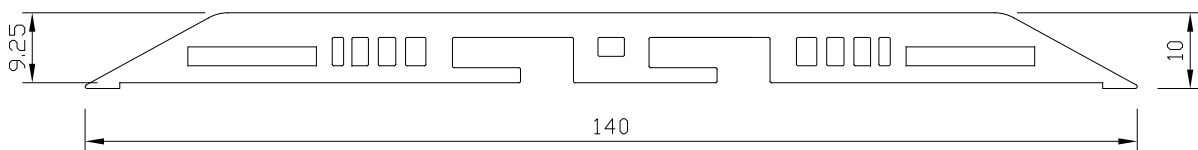

Art. 286

■ FLESSIBILE FLEXIBLE 1 □ FLESSIBILE FLEXIBLE 2 □ RIGIDO RIGID ▣ ESPANSO EXPANDED

▶ A termini di legge, ci riserviamo la proprietà di questi disegni con il divieto di riprodurli e di cederli a terzi senza la nostra autorizzazione.

▶ We reserve all rights on the property of these drawings with warning not to reproduce or to deliver to other parties without our authorization.

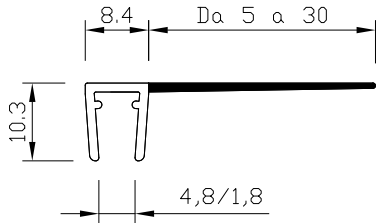

Art. 288

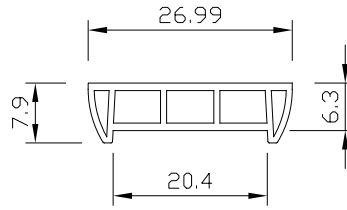

Art. 289

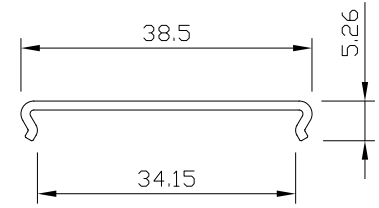

Art. 290

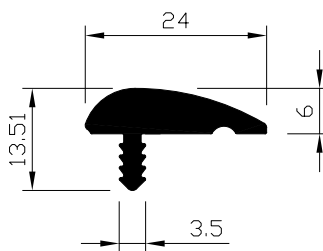

Art. 291

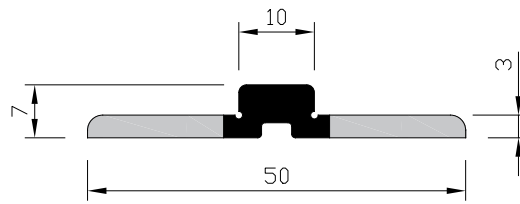

Art. 292

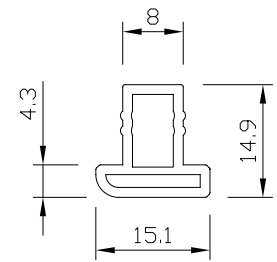

Art. 294

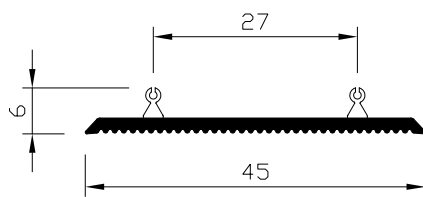

Art. 293

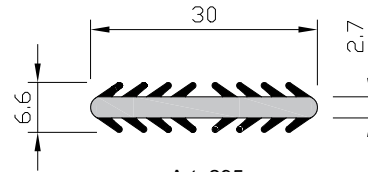

Art. 295

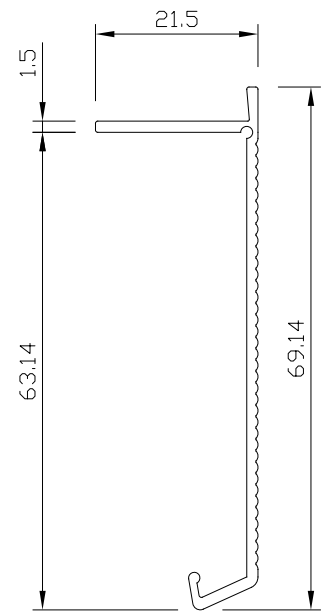

Art. 298

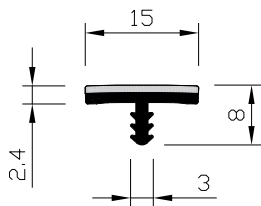

Art. 296

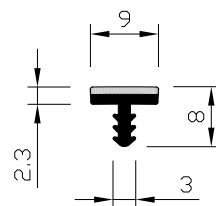

Art. 297

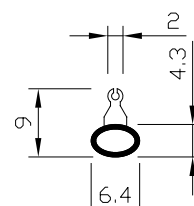

Art. 299

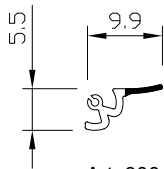

Art. 300

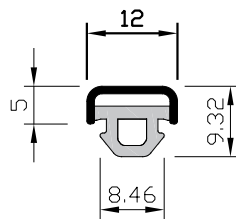

Art. 301

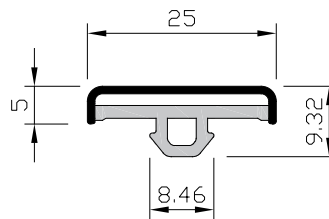

Art. 302

■ FLESSIBILE *FLEXIBLE 1* □ FLESSIBILE *FLEXIBLE 2* □ RIGIDO *RIGID* □ ESPANSO *EXPANDED*

▶ A termini di legge, ci riserviamo la proprietà di questi disegni con il divieto di riprodurli e di cederli a terzi senza la nostra autorizzazione.

▶ We reserve all rights on the property of these drawings with warning not to reproduce or to deliver to other parties without our authorization.

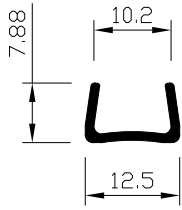

Art. 303

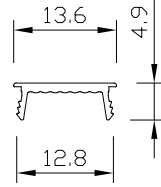

Art. 304

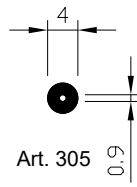

Art. 305

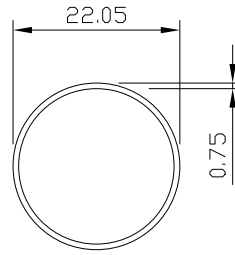

Art. 306

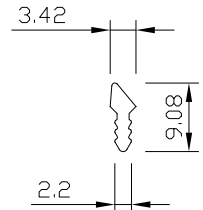

Art. 308

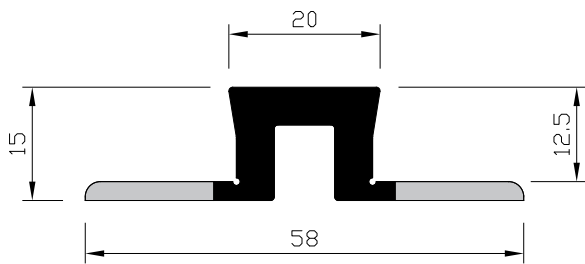

Art. 307

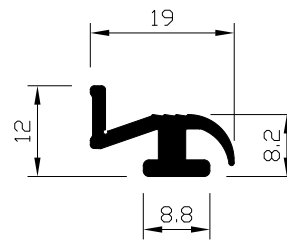

Art. 309

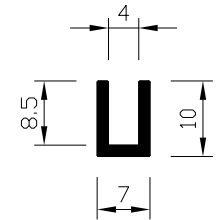

Art. 310

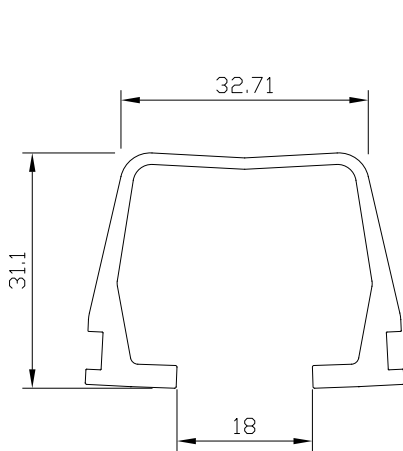

Art. 311

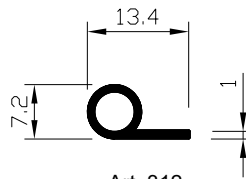

Art. 312

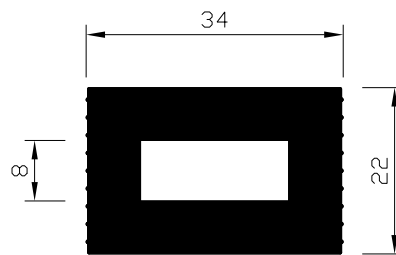

Art. 314

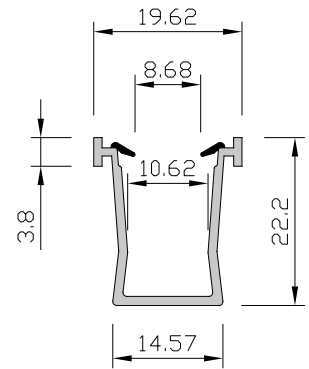

Art. 313

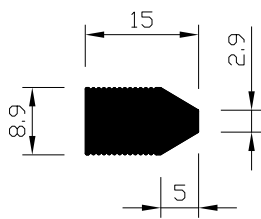

Art. 315

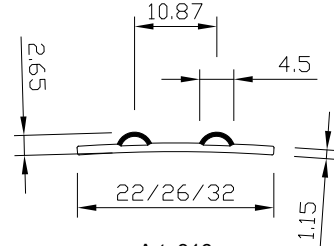

Art. 316

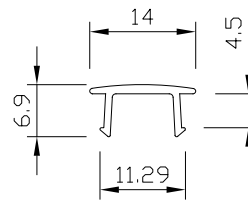

Art. 317

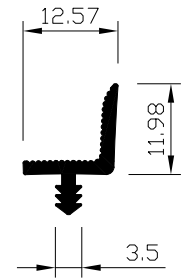

Art. 318

■ FLESSIBILE FLEXIBLE 1 □ FLESSIBILE FLEXIBLE 2 □ RIGIDO RIGID ▣ ESPANSO EXPANDED

▶ A termini di legge, ci riserviamo la proprietà di questi disegni con il divieto di riprodurli e di cederli a terzi senza la nostra autorizzazione.

▶ We reserve all rights on the property of these drawings with warning not to reproduce or to deliver to other parties without our authorization.

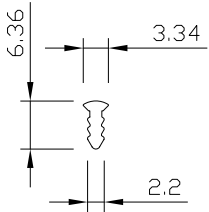

Art. 319

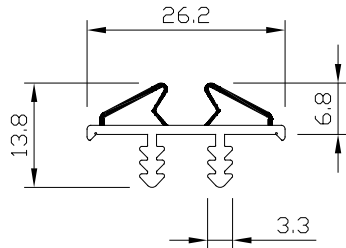

Art. 320

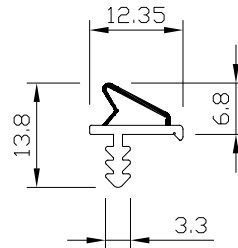

Art. 321

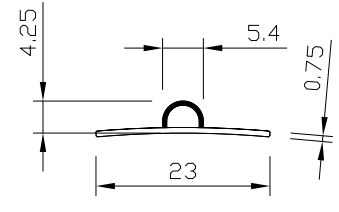

Art. 322

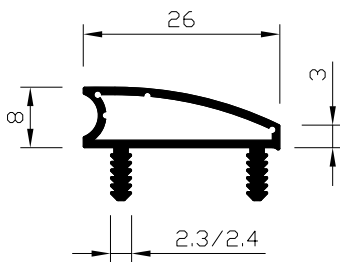

Art. 323

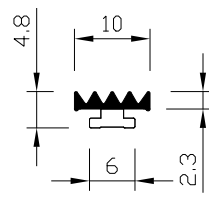

Art. 324

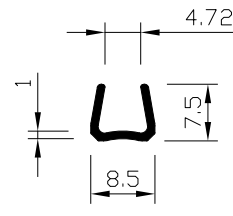

Art. 326

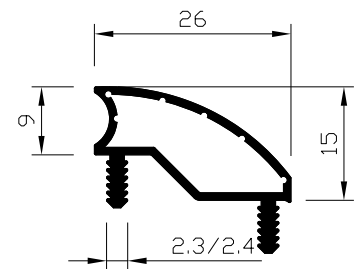

Art. 327

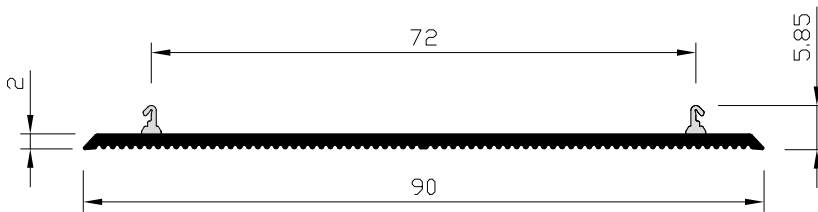

Art. 325

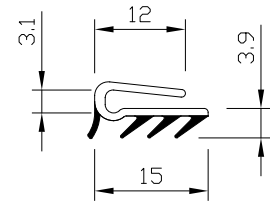

Art. 328

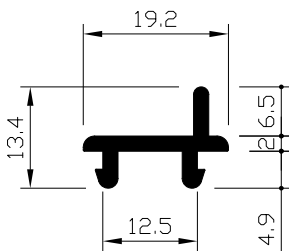

Art. 329

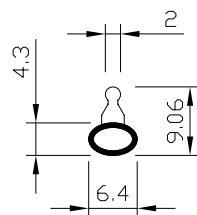

Art. 330

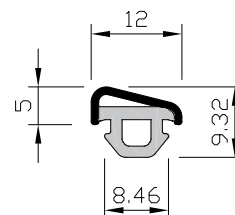

Art. 331

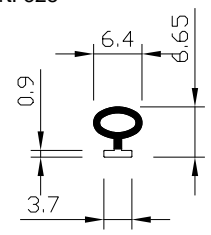

Art. 334

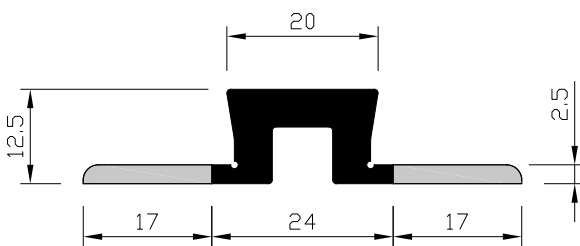

Art. 332

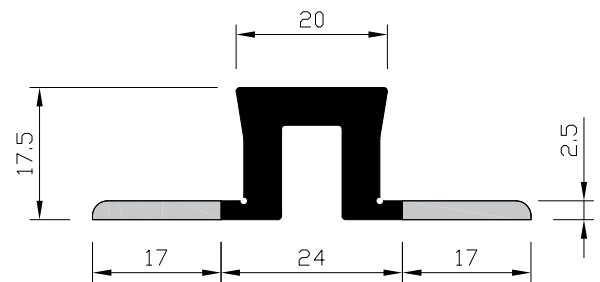

Art. 333

■ FLESSIBILE *FLEXIBLE 1* □ FLESSIBILE *FLEXIBLE 2* □ RIGIDO *RIGID* □ ESPANSO *EXPANDED*

▶ A termini di legge, ci riserviamo la proprietà di questi disegni con il divieto di riprodurli e di cederli a terzi senza la nostra autorizzazione.

▶ We reserve all rights on the property of these drawings with warning not to reproduce or to deliver to other parties without our authorization.

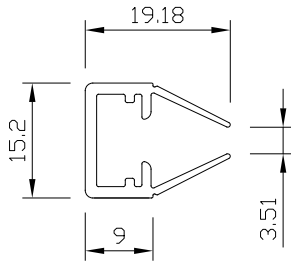

Art. 335

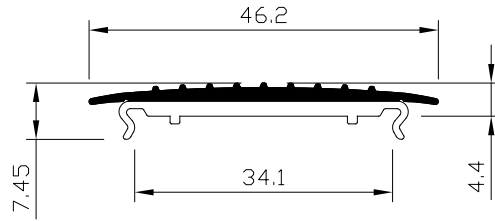

Art. 336

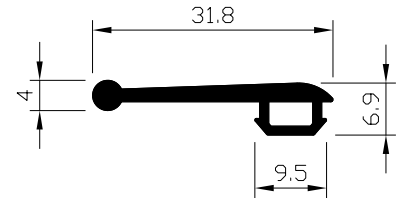

Art. 338

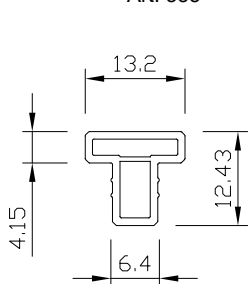

Art. 337

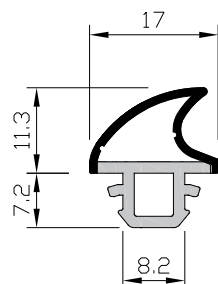

Art. 339

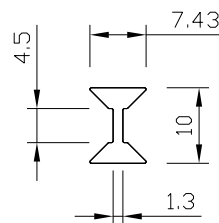

Art. 340

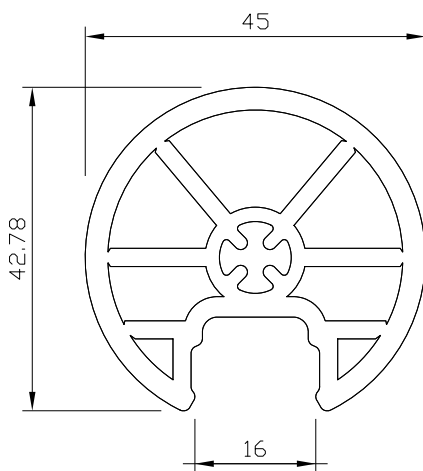

Art. 341

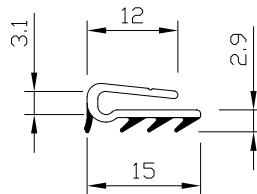

Art. 344

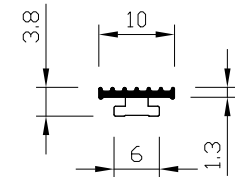

Art. 345

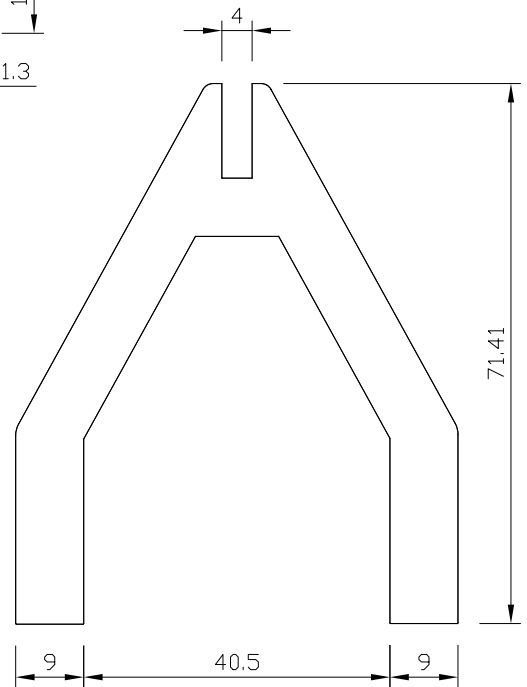

Art. 342

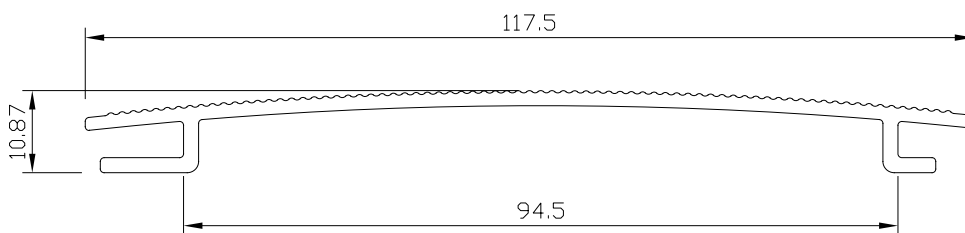

Art. 343

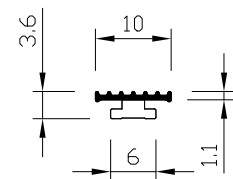

Art. 346

■ FLESSIBILE *FLEXIBLE 1* □ FLESSIBILE *FLEXIBLE 2* □ RIGIDO *RIGID* ▣ ESPANSO *EXPANDED*

▶ A termini di legge, ci riserviamo la proprietà di questi disegni con il divieto di riprodurli e di cederli a terzi senza la nostra autorizzazione.

▶ We reserve all rights on the property of these drawings with warning not to reproduce or to deliver to other parties without our authorization.

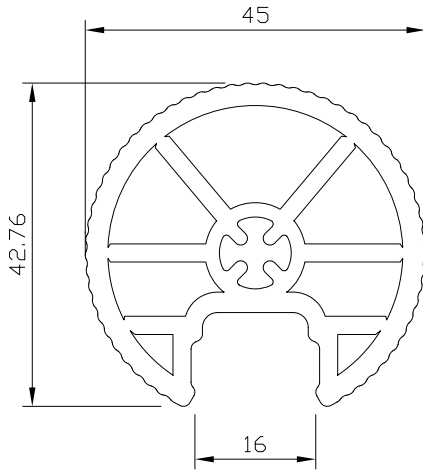

Art. 347

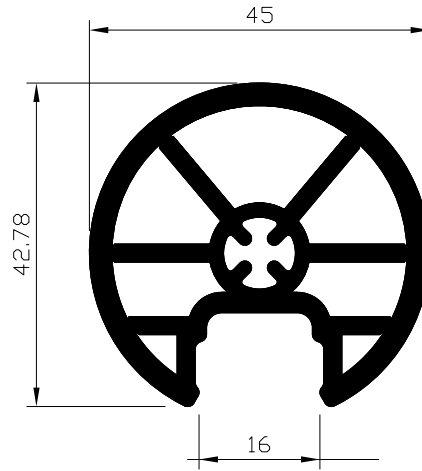

Art. 348

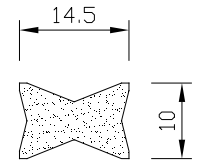

Art. 350

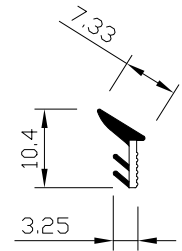

Art. 351

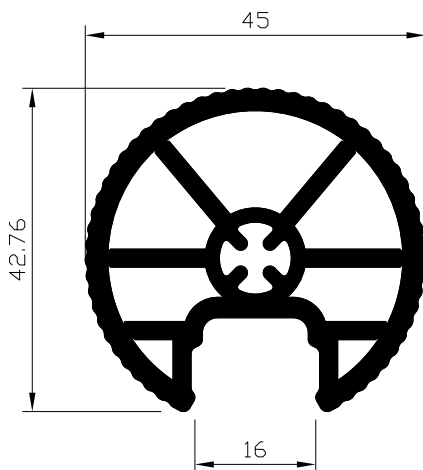

Art. 349

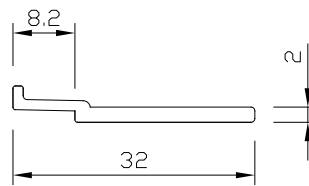

Art. 352

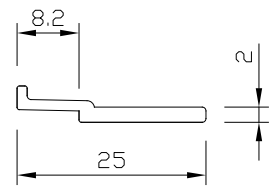

Art. 353

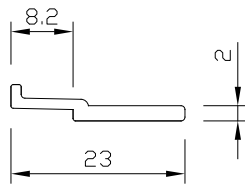

Art. 354

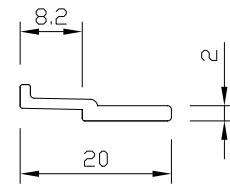

Art. 355

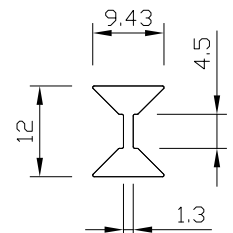

Art. 356

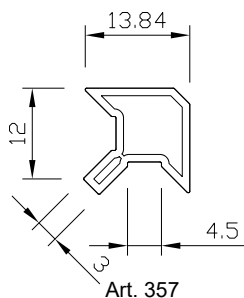

Art. 357

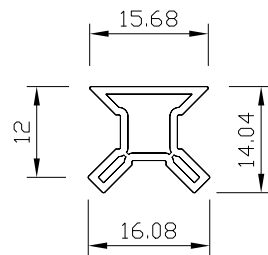

Art. 358

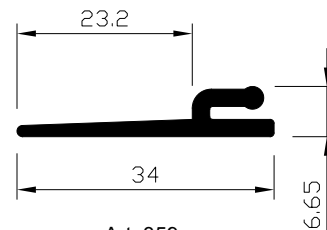

Art. 359

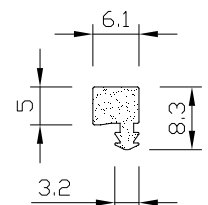

Art. 360

■ FLESSIBILE FLEXIBLE 1 □ FLESSIBILE FLEXIBLE 2 □ RIGIDO RIGID ▣ ESPANSO EXPANDED

▶ A termini di legge, ci riserviamo la proprietà di questi disegni con il divieto di riprodurli e di cederli a terzi senza la nostra autorizzazione.

▶ We reserve all rights on the property of these drawings with warning not to reproduce or to deliver to other parties without our authorization.

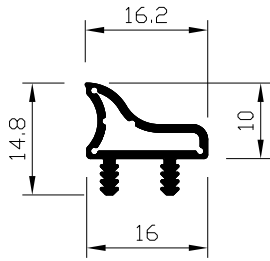

Art. 361

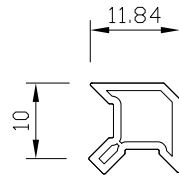

Art. 363

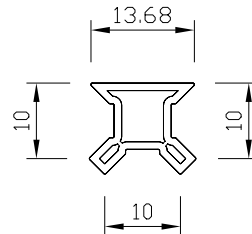

Art. 364

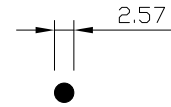

Art. 362

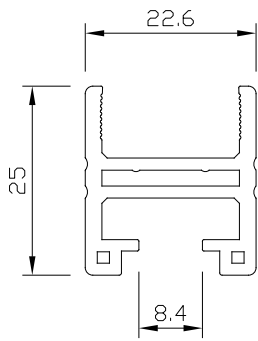

Art. 365

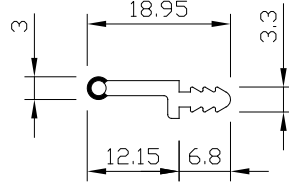

Art. 366

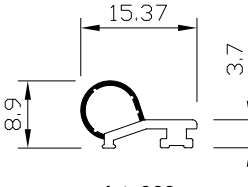

Art. 368

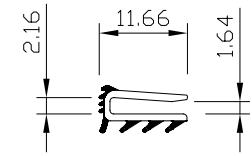

Art. 369

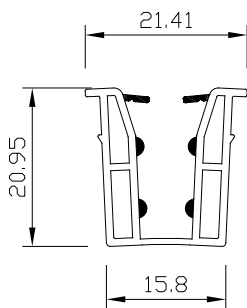

Art. 372

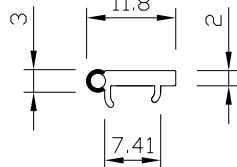

Art. 367

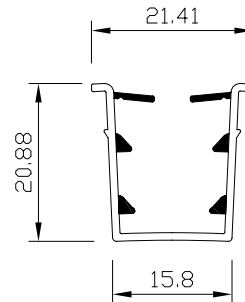

Art. 370

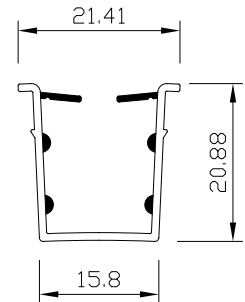

Art. 371

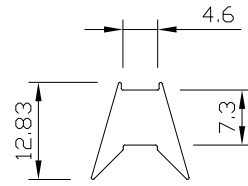

Art. 374

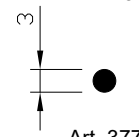

Art. 377

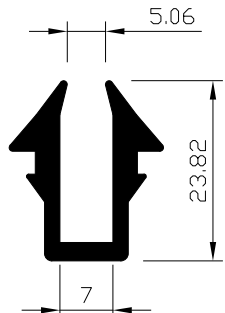

Art. 378

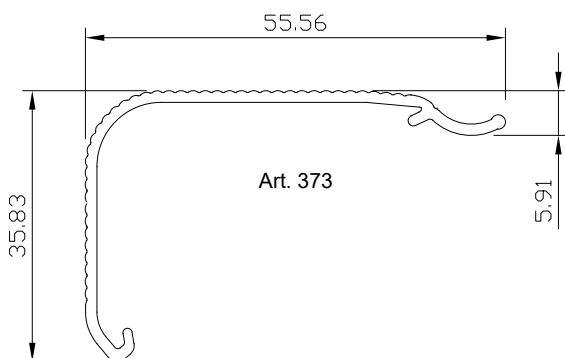

Art. 373

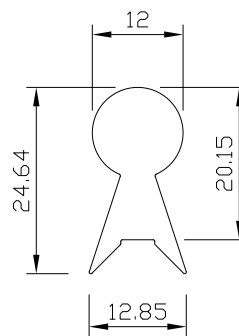

Art. 375

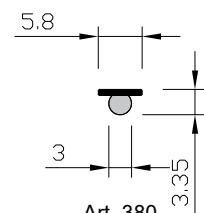

Art. 380

■ FLESSIBILE *FLEXIBLE 1* □ FLESSIBILE *FLEXIBLE 2* □ RIGIDO *RIGID* □ ESPANSO *EXPANDED*

▶ A termini di legge, ci riserviamo la proprietà di questi disegni con il divieto di riprodurli e di cederli a terzi senza la nostra autorizzazione.

▶ We reserve all rights on the property of these drawings with warning not to reproduce or to deliver to other parties without our authorization.

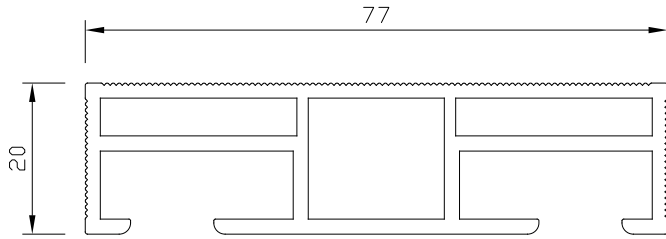

Art. 376

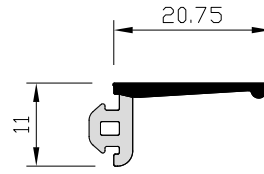

Art. 379

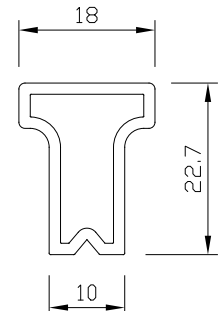

Art. 381

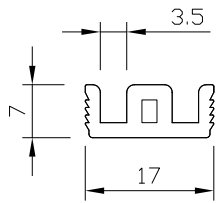

Art. 382

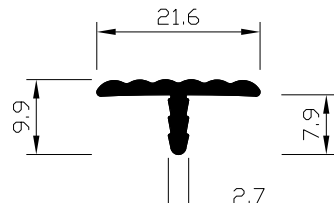

Art. 383

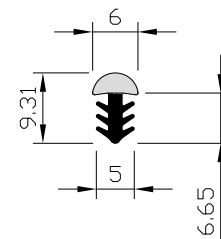

Art. 384

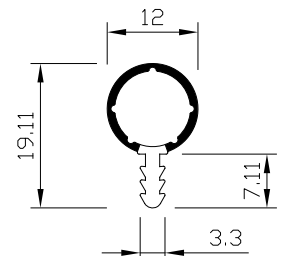

Art. 385

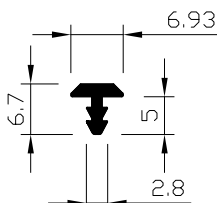

Art. 386

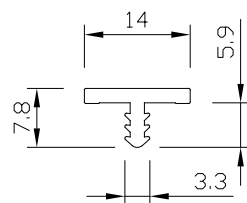

Art. 387

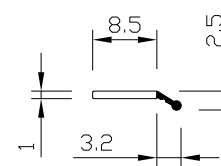

Art. 388

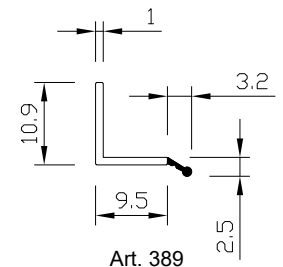

Art. 389

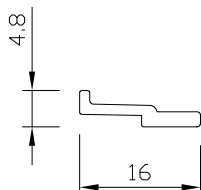

Art. 390

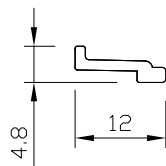

Art. 391

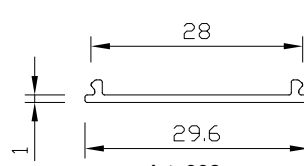

Art. 392

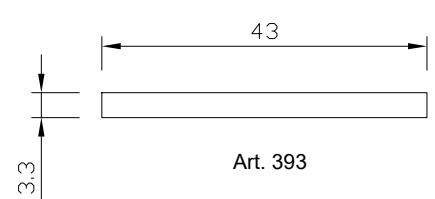

Art. 393

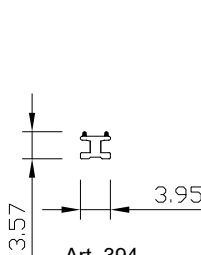

Art. 394

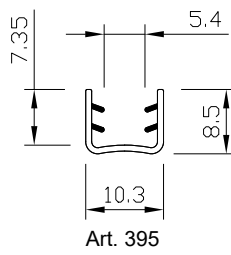

Art. 395

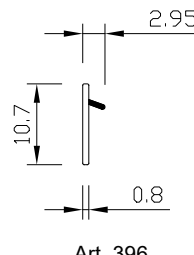

Art. 396

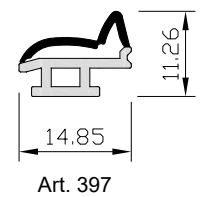

Art. 397

■ FLESSIBILE FLEXIBLE 1 □ FLESSIBILE FLEXIBLE 2 □ RIGIDO RIGID ▣ ESPANSO EXPANDED

▶ A termini di legge, ci riserviamo la proprietà di questi disegni con il divieto di riprodurli e di cederli a terzi senza la nostra autorizzazione.

▶ We reserve all rights on the property of these drawings with warning not to reproduce or to deliver to other parties without our authorization.

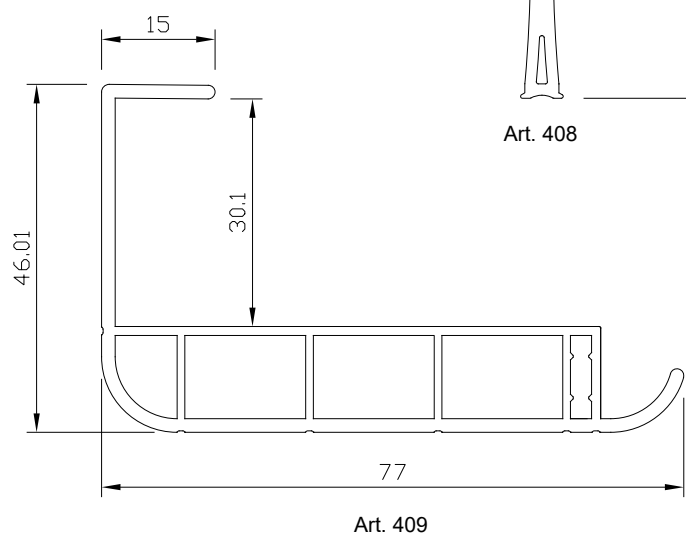
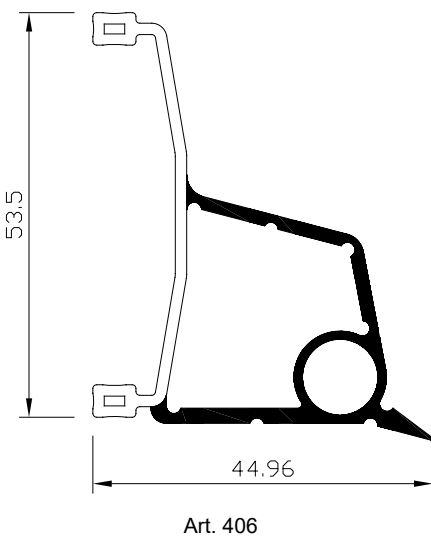
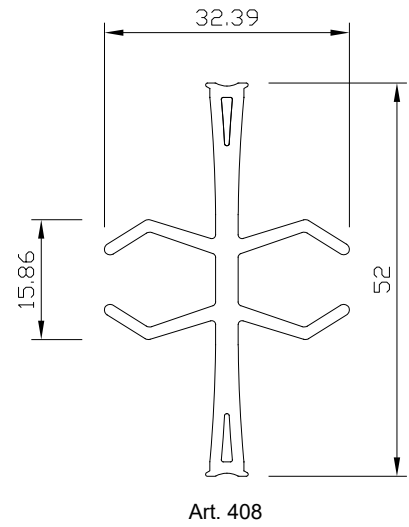
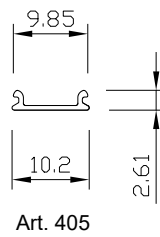
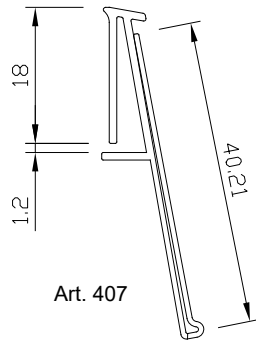
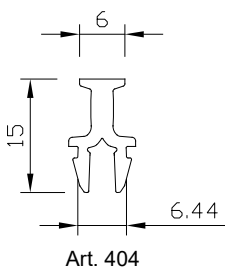
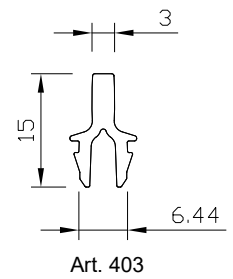
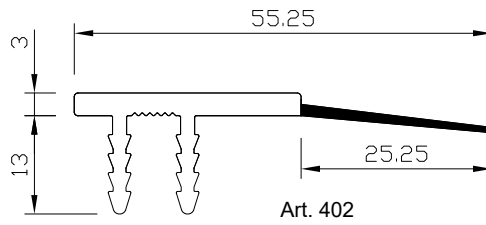
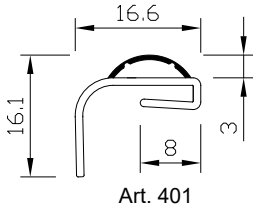
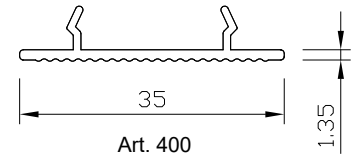
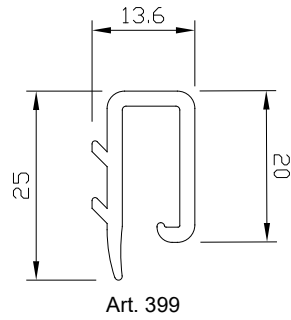
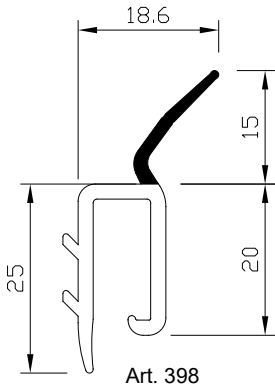

■ FLESSIBILE FLEXIBLE 1 □ FLESSIBILE FLEXIBLE 2 □ RIGIDO RIGID ▣ ESPANSO EXPANDED

▶ A termini di legge, ci riserviamo la proprietà di questi disegni con il divieto di riprodurli e di cederli a terzi senza la nostra autorizzazione.

▶ We reserve all rights on the property of these drawings with warning not to reproduce or to deliver to other parties without our authorization.

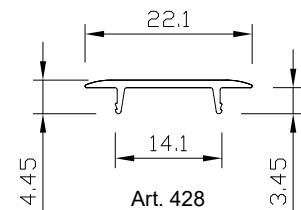
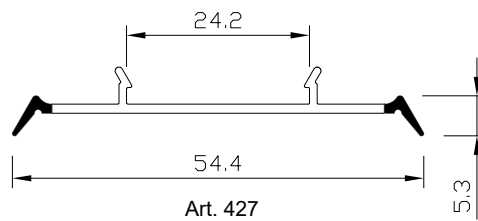
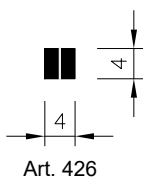
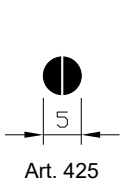
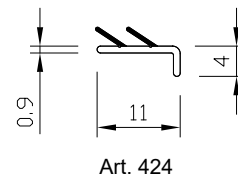
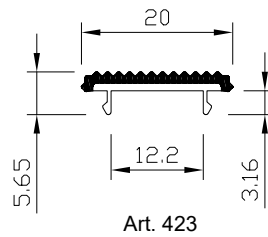
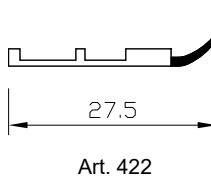
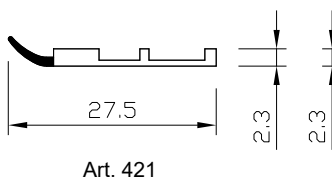
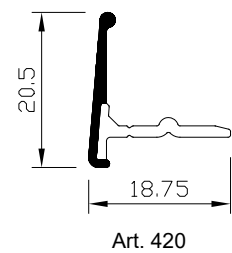
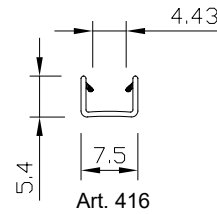
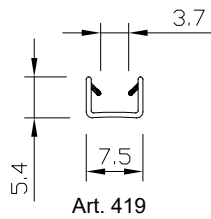
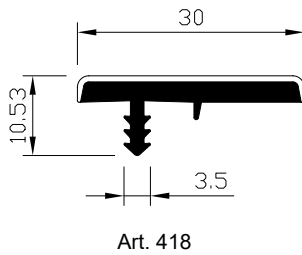
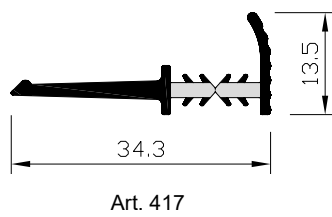
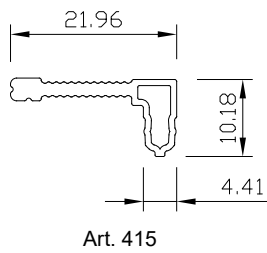
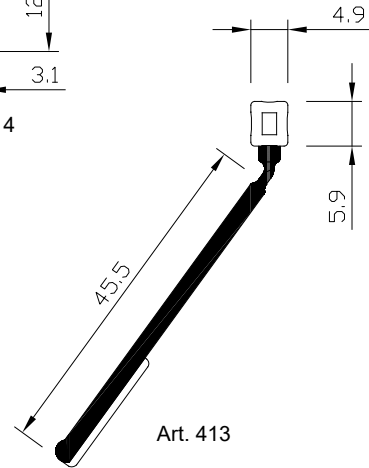
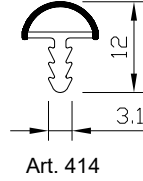
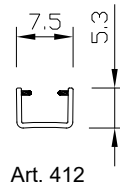
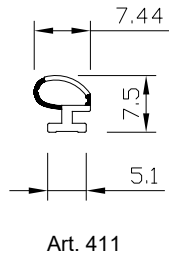
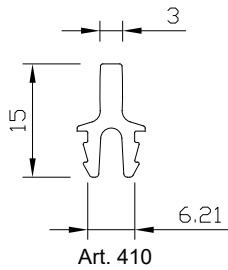

■ FLESSIBILE *FLEXIBLE 1* □ FLESSIBILE *FLEXIBLE 2* □ RIGIDO *RIGID* □ ESPANSO *EXPANDED*

▶ A termini di legge, ci riserviamo la proprietà di questi disegni con il divieto di riprodurli e di cederli a terzi senza la nostra autorizzazione.

▶ We reserve all rights on the property of these drawings with warning not to reproduce or to deliver to other parties without our authorization.

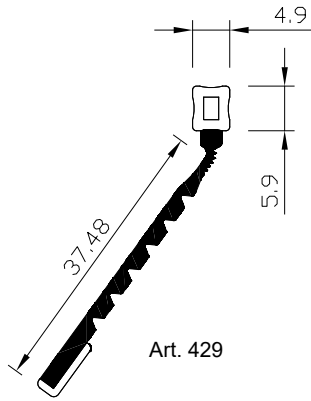

Art. 429

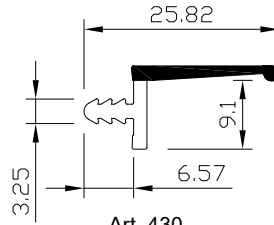

Art. 430

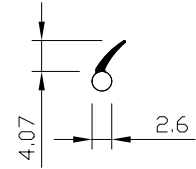

Art. 431

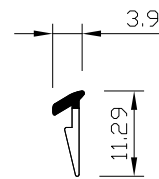

Art. 432

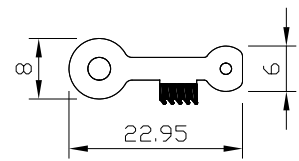

Art. 433

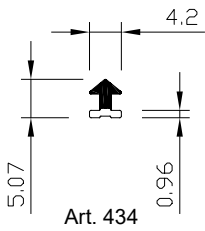

Art. 434

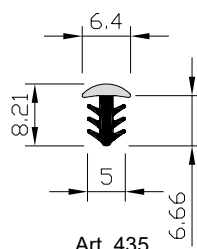

Art. 435

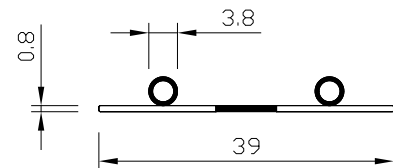

Art. 436

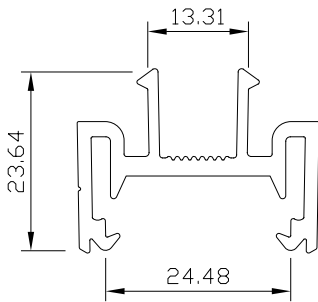

Art. 437

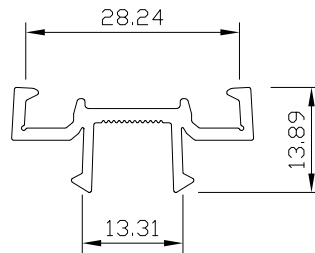

Art. 438

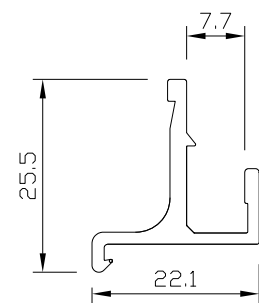

Art. 439

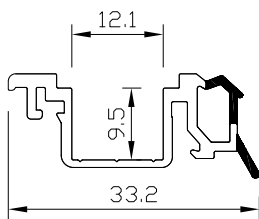

Art. 440

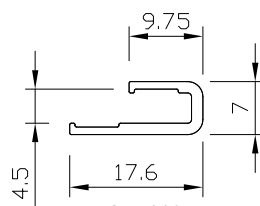

Art. 441

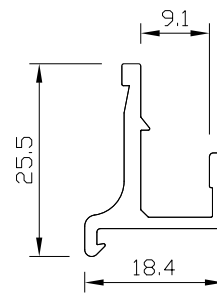

Art. 442

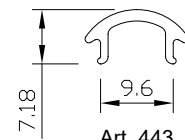

Art. 443

■ FLESSIBILE FLEXIBLE 1 □ FLESSIBILE FLEXIBLE 2 □ RIGIDO RIGID ▣ ESPANSO EXPANDED

▶ A termini di legge, ci riserviamo la proprietà di questi disegni con il divieto di riprodurli e di cederli a terzi senza la nostra autorizzazione.

▶ We reserve all rights on the property of these drawings with warning not to reproduce or to deliver to other parties without our authorization.

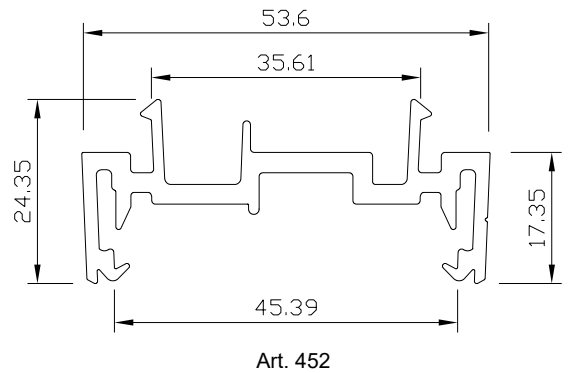
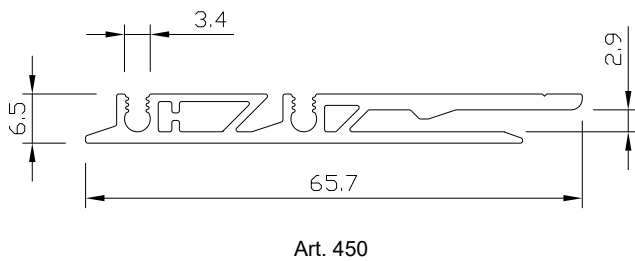
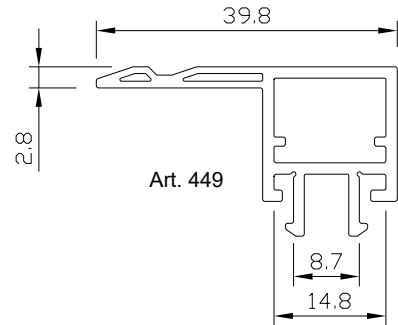
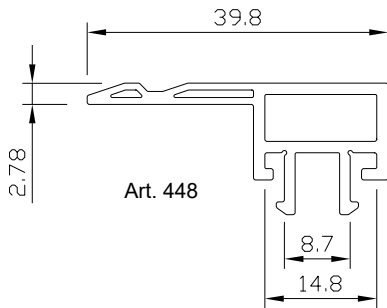
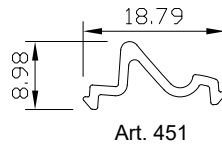
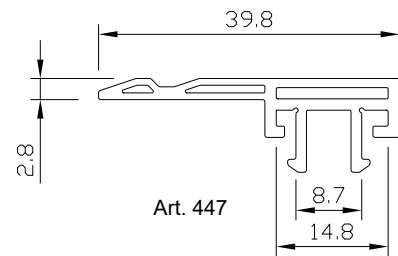
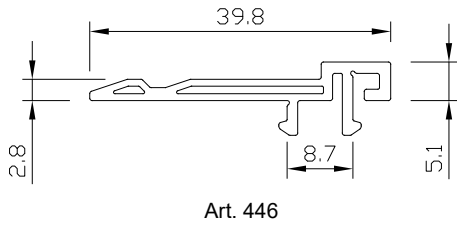
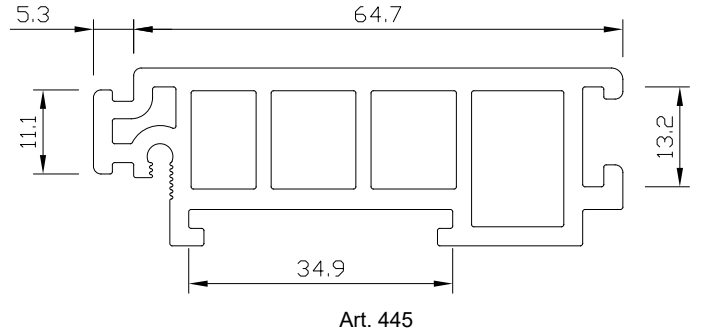
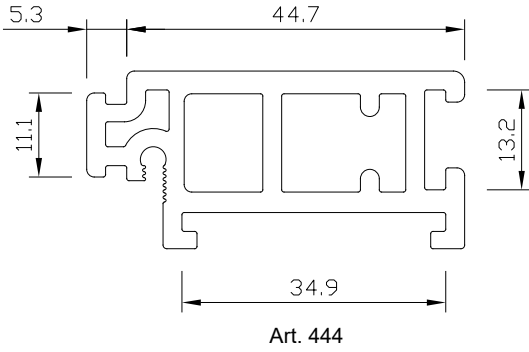

■ FLESSIBILE *FLEXIBLE 1* □ FLESSIBILE *FLEXIBLE 2* □ RIGIDO *RIGID* ▣ ESPANSO *EXPANDED*

▶ A termini di legge, ci riserviamo la proprietà di questi disegni con il divieto di riprodurli e di cederli a terzi senza la nostra autorizzazione.

▶ We reserve all rights on the property of these drawings with warning not to reproduce or to deliver to other parties without our authorization.

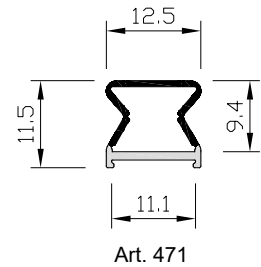
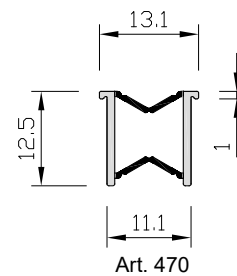
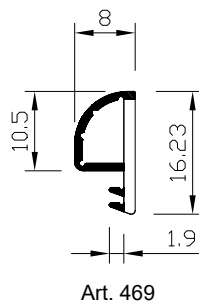
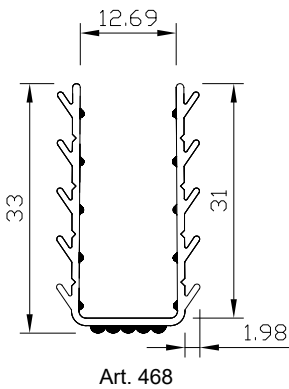
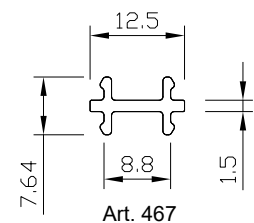
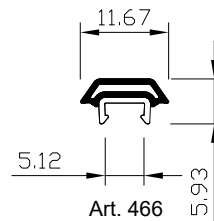
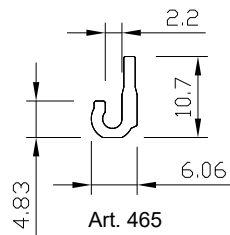
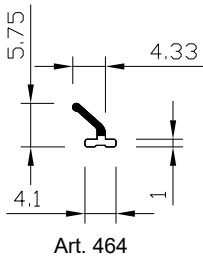
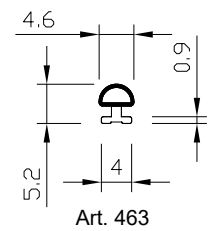
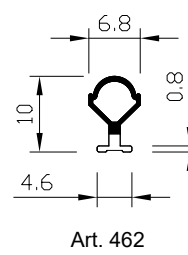
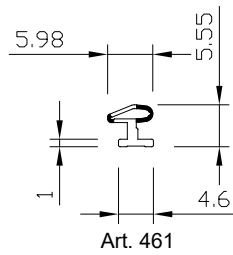
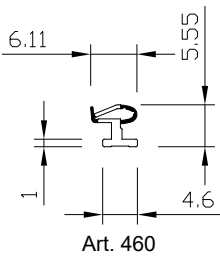
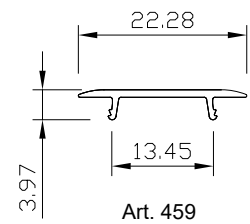
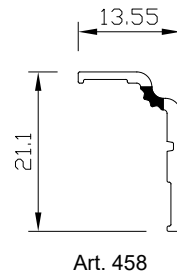
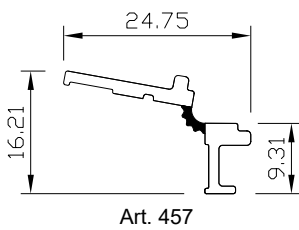
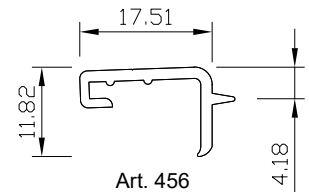
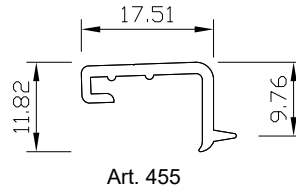
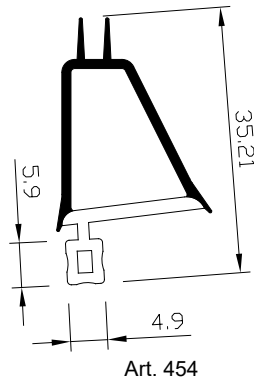
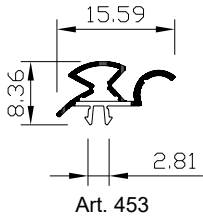

■ FLESSIBILE FLEXIBLE 1 □ FLESSIBILE FLEXIBLE 2 □ RIGIDO RIGID ▣ ESPANSO EXPANDED

▶ A termini di legge, ci riserviamo la proprietà di questi disegni con il divieto di riprodurli e di cederli a terzi senza la nostra autorizzazione.

▶ We reserve all rights on the property of these drawings with warning not to reproduce or to deliver to other parties without our authorization.

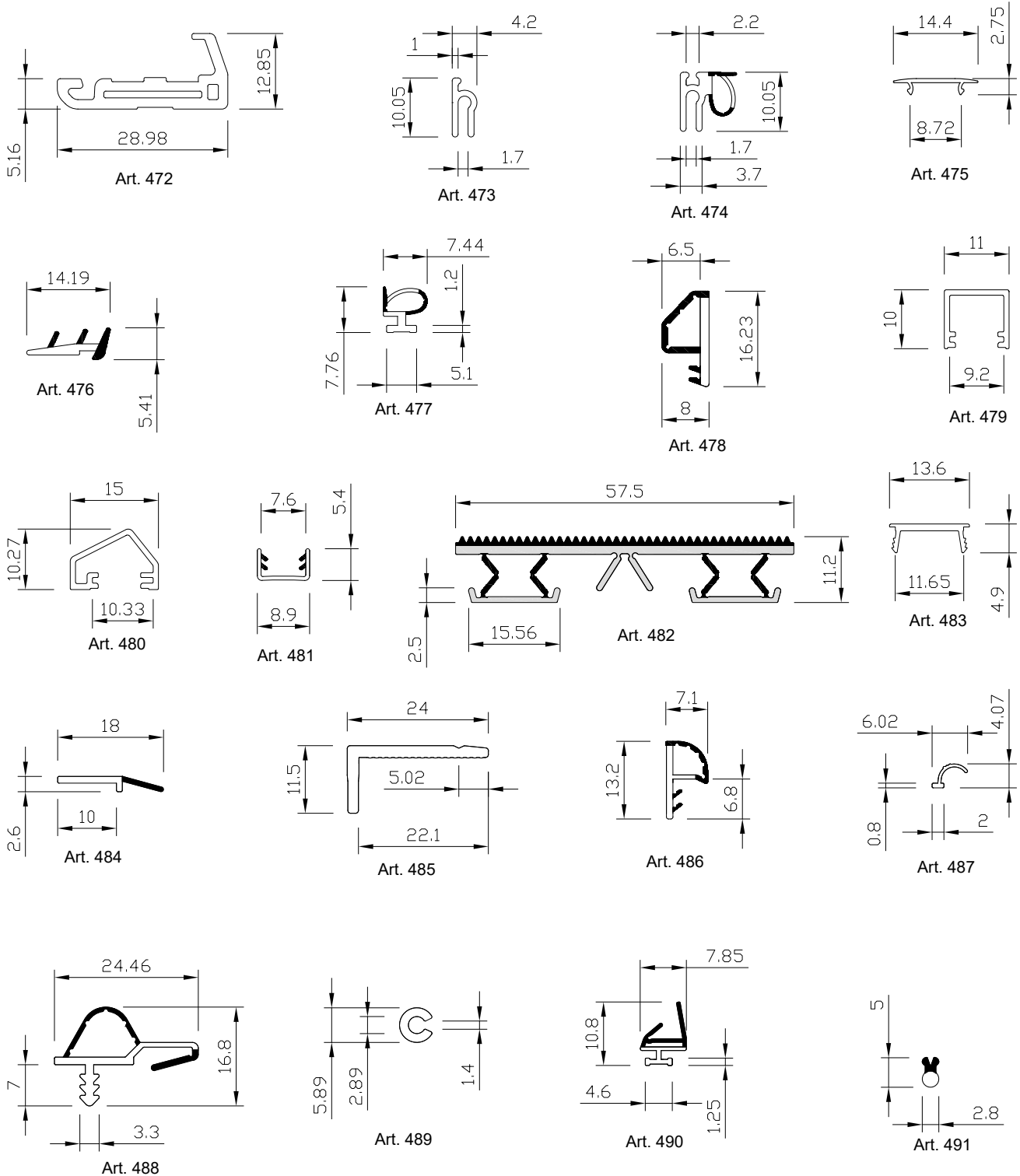

■ FLESSIBILE *FLEXIBLE 1* □ FLESSIBILE *FLEXIBLE 2* □ RIGIDO *RIGID* ▣ ESPANSO *EXPANDED*

▶ A termini di legge, ci riserviamo la proprietà di questi disegni con il divieto di riprodurli e di cederli a terzi senza la nostra autorizzazione.

▶ We reserve all rights on the property of these drawings with warning not to reproduce or to deliver to other parties without our authorization.

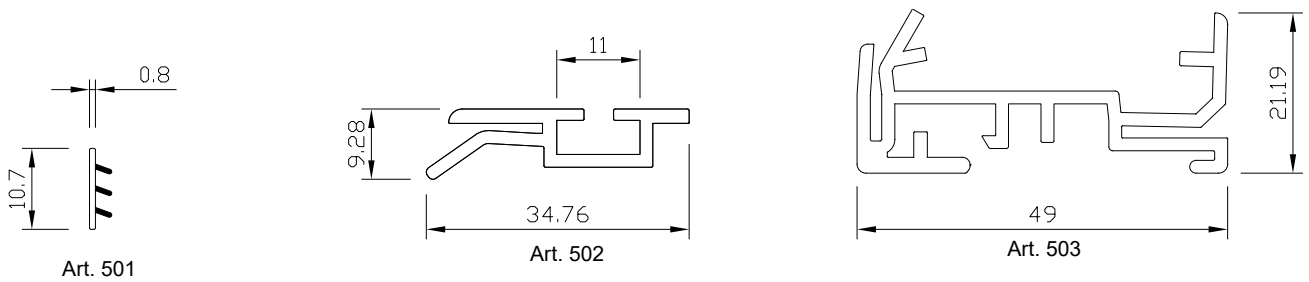
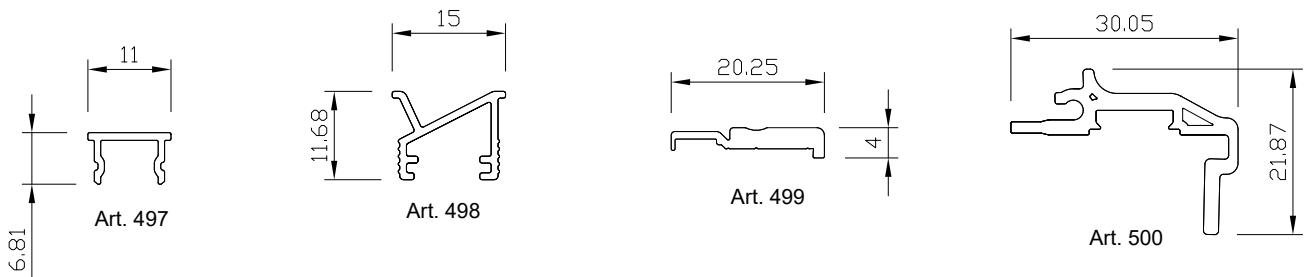
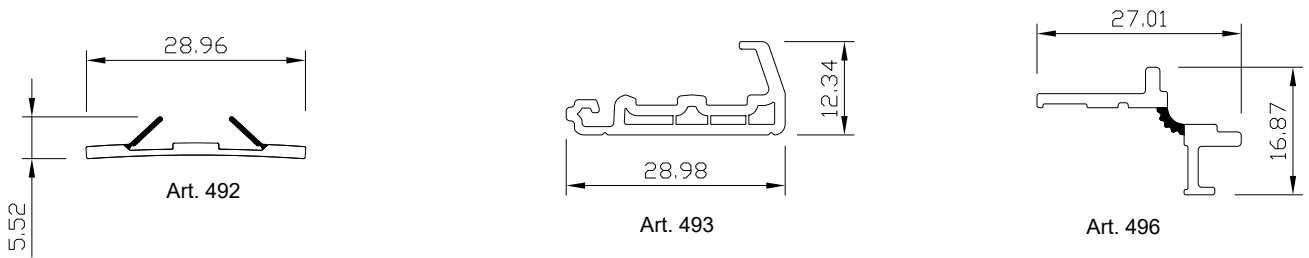
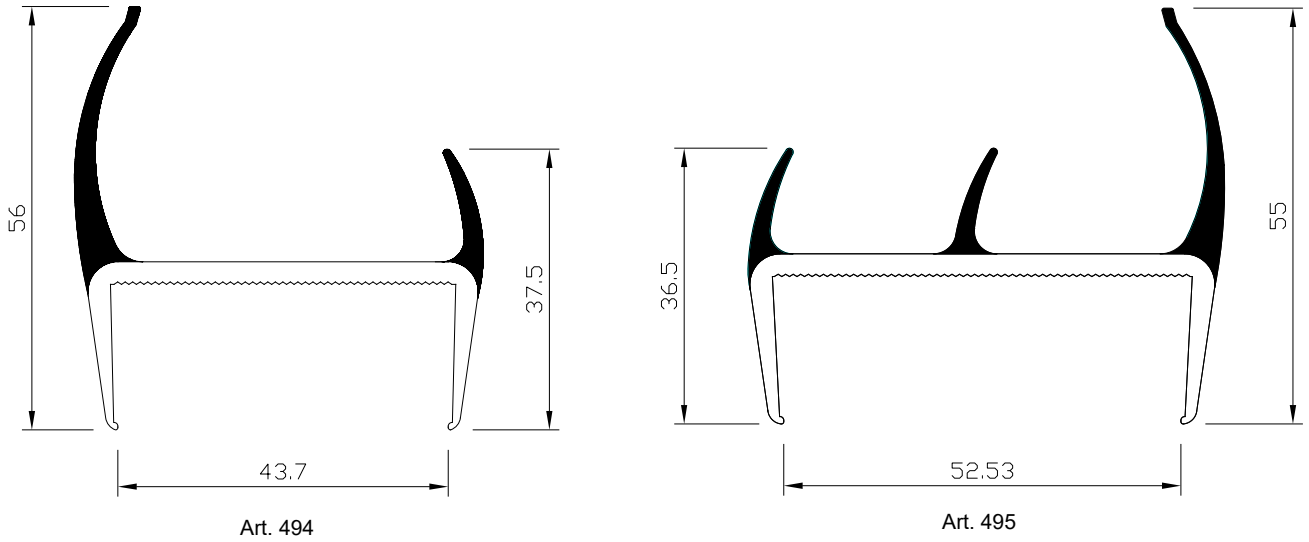

■ FLESSIBILE *FLEXIBLE 1* □ FLESSIBILE *FLEXIBLE 2* □ RIGIDO *RIGID* ▣ ESPANSO *EXPANDED*

▶ A termini di legge, ci riserviamo la proprietà di questi disegni con il divieto di riprodurli e di cederli a terzi senza la nostra autorizzazione.

▶ We reserve all rights on the property of these drawings with warning not to reproduce or to deliver to other parties without our authorization.

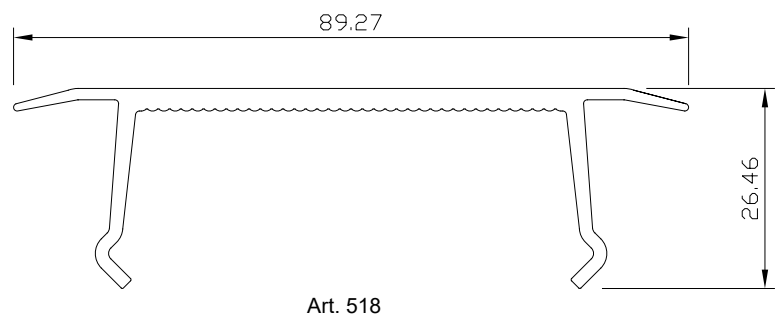
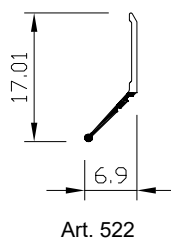
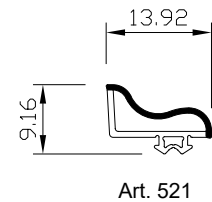
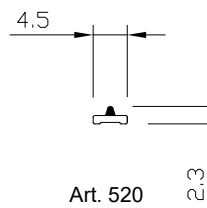
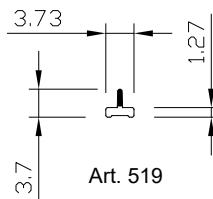
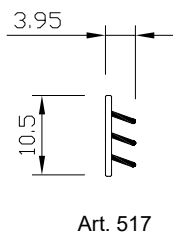
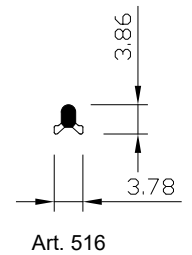
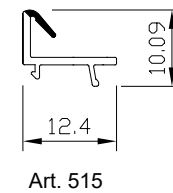
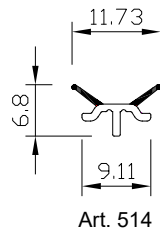
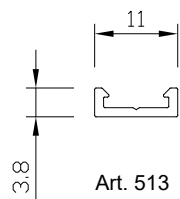
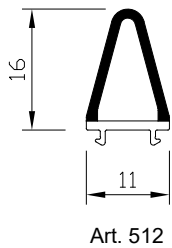
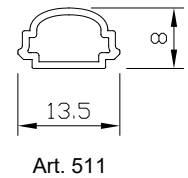
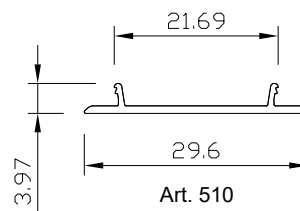
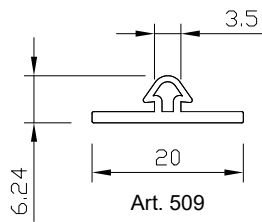
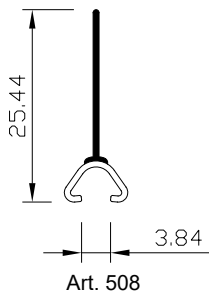
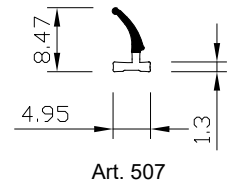
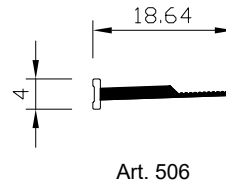
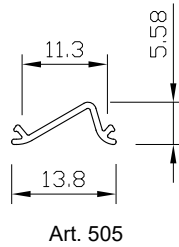
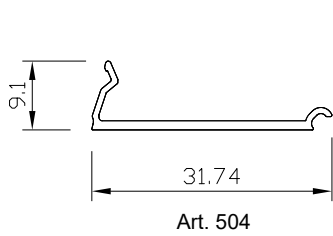

■ FLESSIBILE FLEXIBLE 1 □ FLESSIBILE FLEXIBLE 2 □ RIGIDO RIGID ▣ ESPANSO EXPANDED

▶ A termini di legge, ci riserviamo la proprietà di questi disegni con il divieto di riprodurli e di cederli a terzi senza la nostra autorizzazione.

▶ We reserve all rights on the property of these drawings with warning not to reproduce or to deliver to other parties without our authorization.

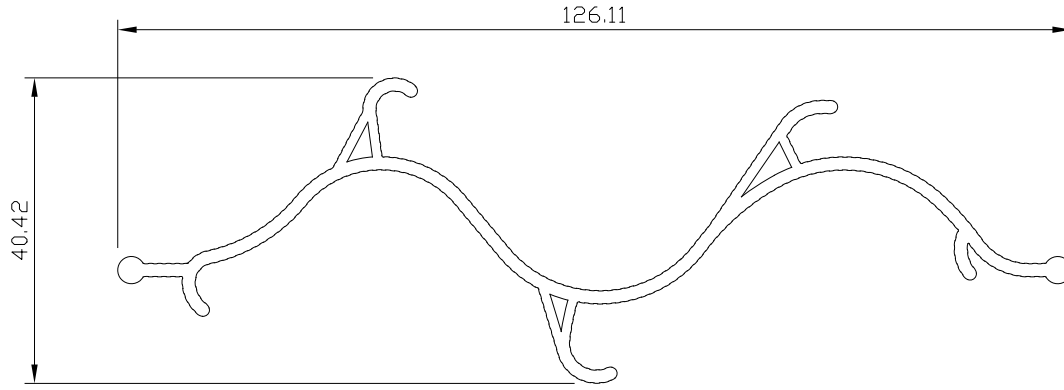

Art. 523



Art. 526

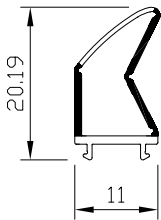

Art. 524

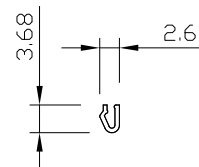

Art. 525

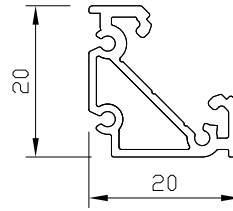

Art. 531

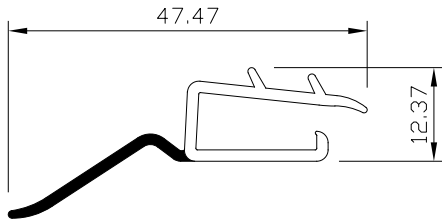

Art. 527

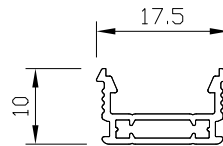

Art. 530

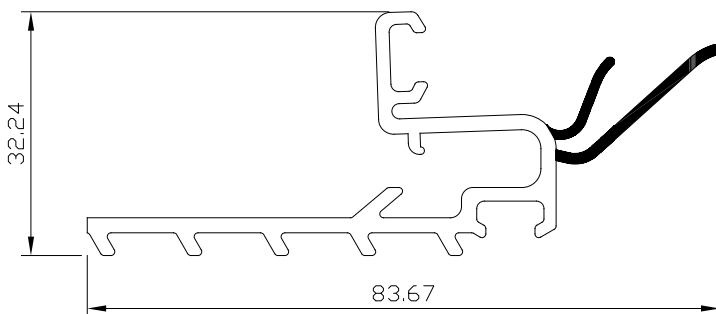

Art. 528

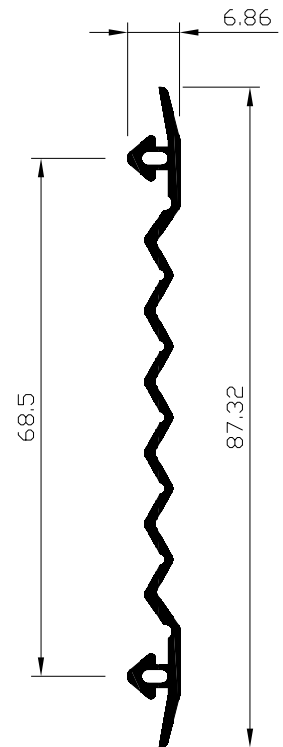

Art. 529

■ FLESSIBILE *FLEXIBLE 1* □ FLESSIBILE *FLEXIBLE 2* □ RIGIDO *RIGID* □ ESPANSO *EXPANDED*

▶ A termini di legge, ci riserviamo la proprietà di questi disegni con il divieto di riprodurli e di cederli a terzi senza la nostra autorizzazione.

▶ We reserve all rights on the property of these drawings with warning not to reproduce or to deliver to other parties without our authorization.

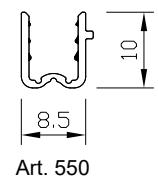
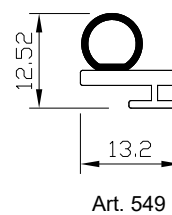
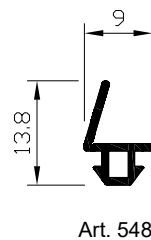
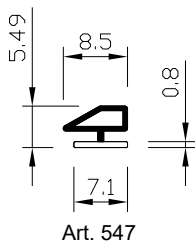
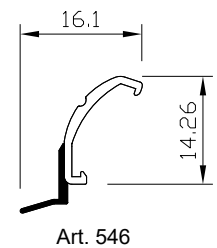
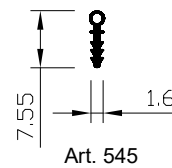
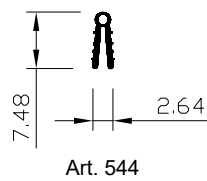
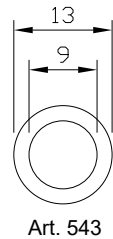
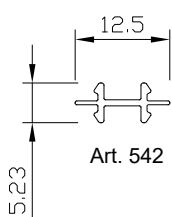
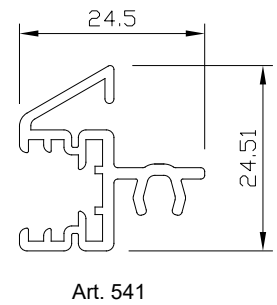
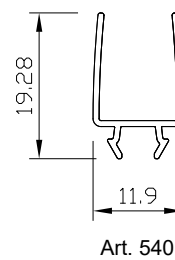
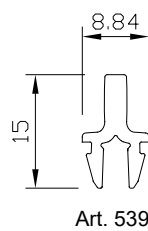
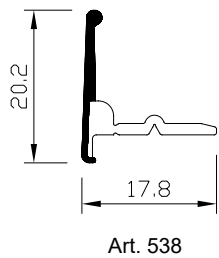
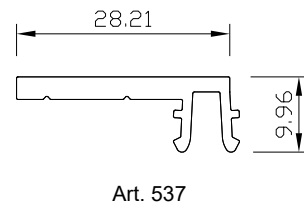
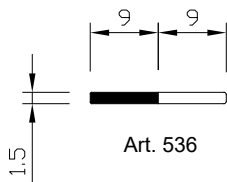
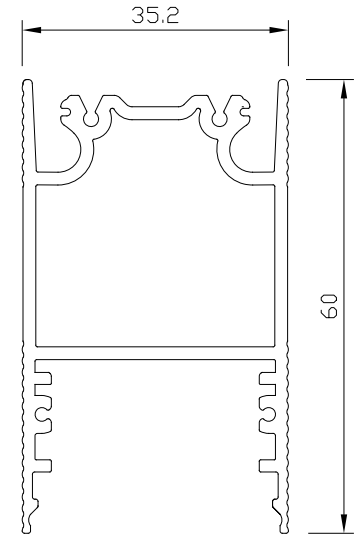
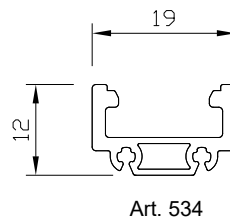
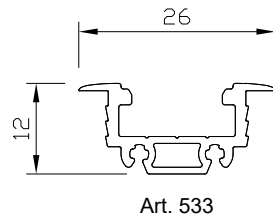
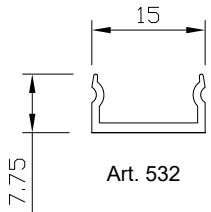

■ FLESSIBILE FLEXIBLE 1 □ FLESSIBILE FLEXIBLE 2 □ RIGIDO RIGID ▣ ESPANSO EXPANDED

▶ A termini di legge, ci riserviamo la proprietà di questi disegni con il divieto di riprodurli e di cederli a terzi senza la nostra autorizzazione.

▶ We reserve all rights on the property of these drawings with warning not to reproduce or to deliver to other parties without our authorization.

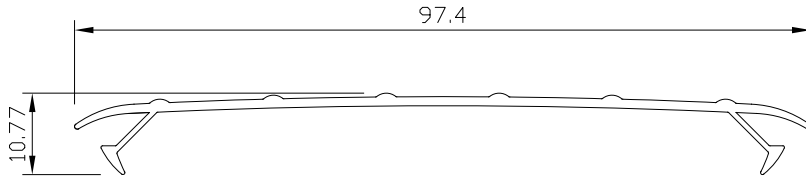

Art. 551

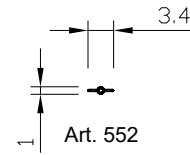

Art. 552

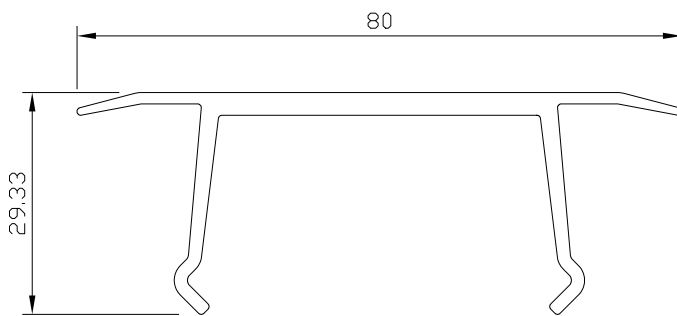

Art. 553

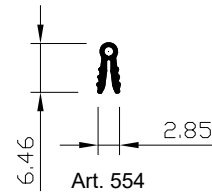

Art. 554

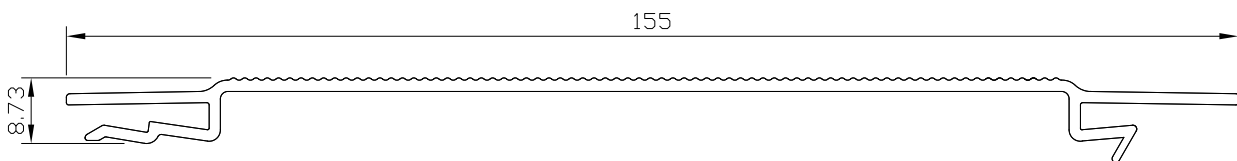

Art. 555

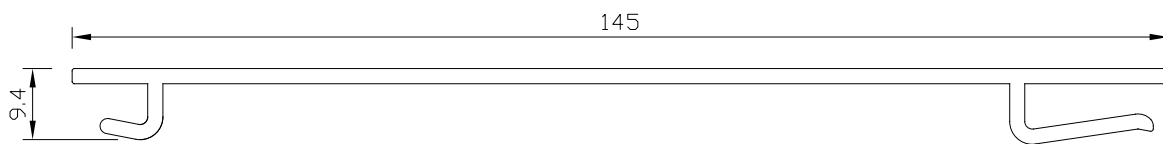

Art. 556

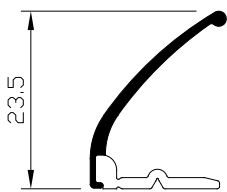

Art. 557

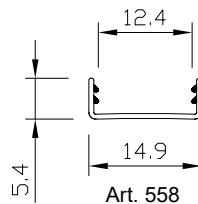

Art. 558

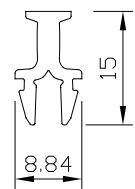

Art. 559

■ FLESSIBILE *FLEXIBLE 1* □ FLESSIBILE *FLEXIBLE 2* □ RIGIDO *RIGID* ▣ ESPANSO *EXPANDED*

▶ A termini di legge, ci riserviamo la proprietà di questi disegni con il divieto di riprodurli e di cederli a terzi senza la nostra autorizzazione.

▶ We reserve all rights on the property of these drawings with warning not to reproduce or to deliver to other parties without our authorization.

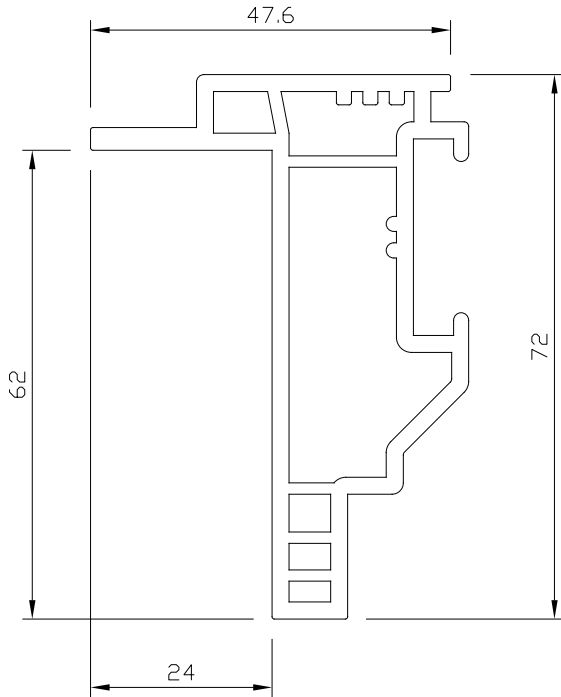

Art. 560

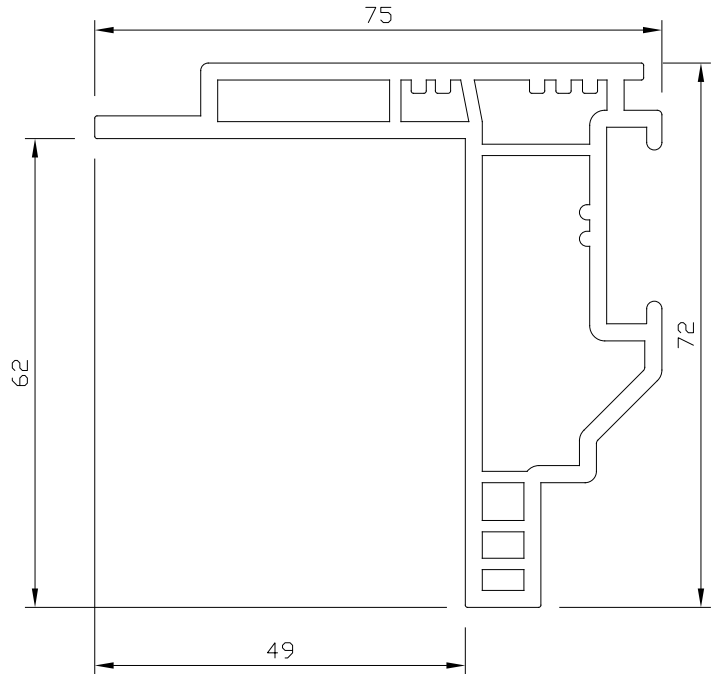

Art. 561

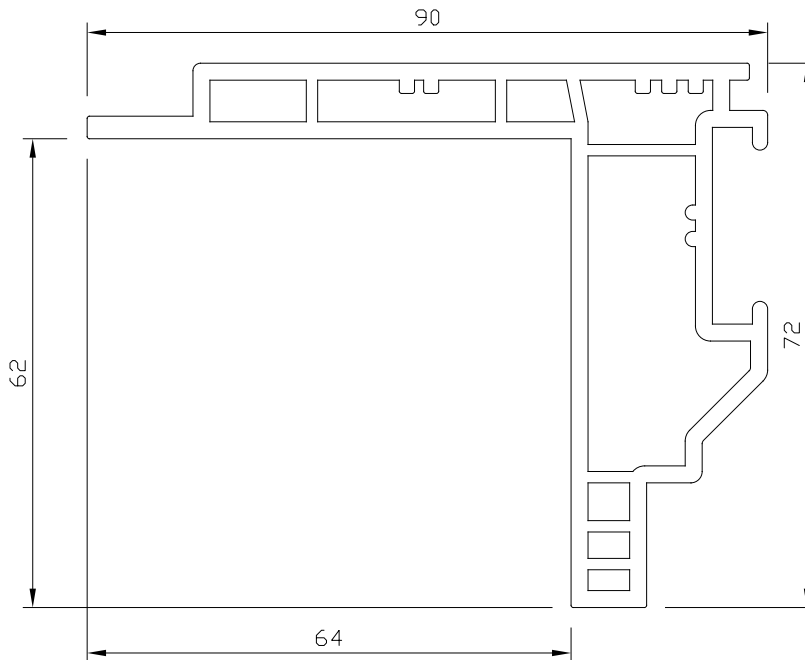

Art. 562

FLESSIBILE *FLEXIBLE 1*
 FLESSIBILE *FLEXIBLE 2*
 RIGIDO *RIGID*
 ESPANSO *EXPANDED*

▶ A termini di legge, ci riserviamo la proprietà di questi disegni con il divieto di riprodurli e di cederli a terzi senza la nostra autorizzazione.

▶ We reserve all rights on the property of these drawings with warning not to reproduce or to deliver to other parties without our authorization.

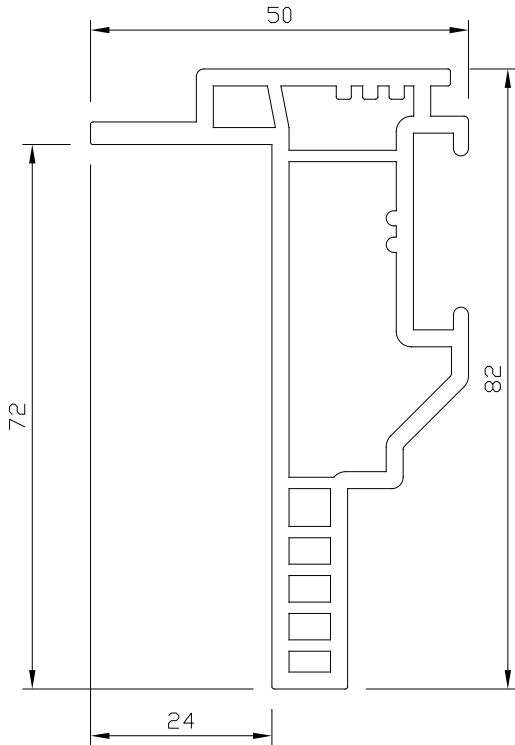

Art. 563

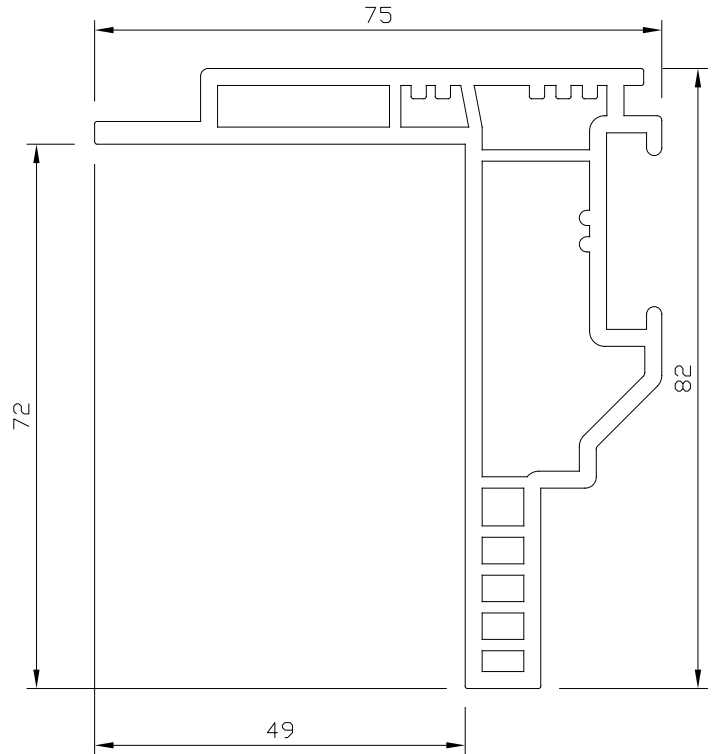

Art. 564

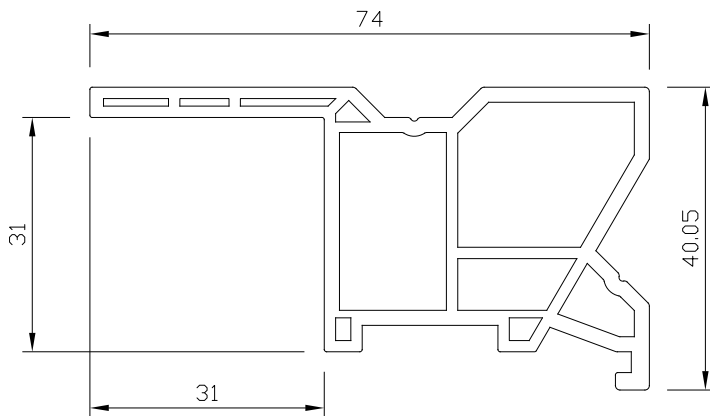

Art. 566

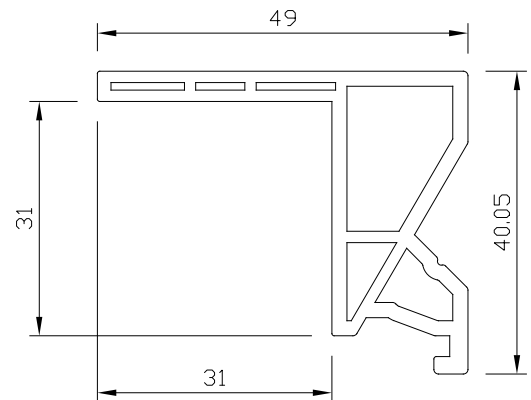

Art. 567

■ FLESSIBILE *FLEXIBLE 1* □ FLESSIBILE *FLEXIBLE 2* □ RIGIDO *RIGID* ▣ ESPANSO *EXPANDED*

▶ A termini di legge, ci riserviamo la proprietà di questi disegni con il divieto di riprodurli e di cederli a terzi senza la nostra autorizzazione.

▶ We reserve all rights on the property of these drawings with warning not to reproduce or to deliver to other parties without our authorization.

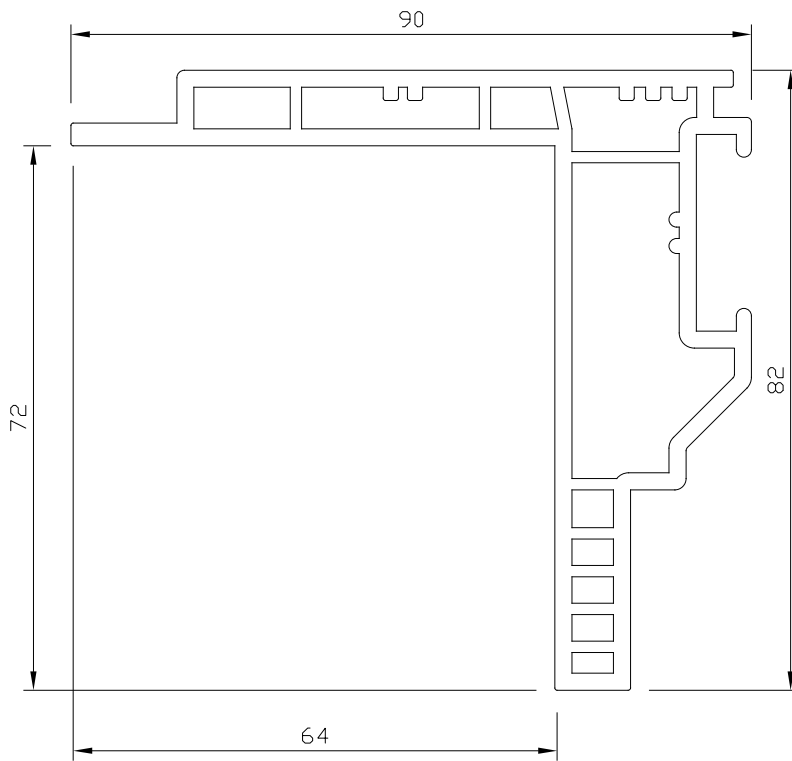

Art. 565



◆ Strada di Oselin 10 • 33047 REMANZACCO Udine • Tel 0432.668877 Fax 0432.668429
E-mail: info@mavisitaly.com • www.mavisitaly.com ◆

■ FLESSIBILE *FLEXIBLE 1* □ FLESSIBILE *FLEXIBLE 2* □ RIGIDO *RIGID* □ ESPANSO *EXPANDED*

▶ A termini di legge, ci riserviamo la proprietà di questi disegni con il divieto di riprodurli e di cederli a terzi senza la nostra autorizzazione.

▶ We reserve all rights on the property of these drawings with warning not to reproduce or to deliver to other parties without our authorization.

50

+ **non hai trovato
il profilo che cercavi?**

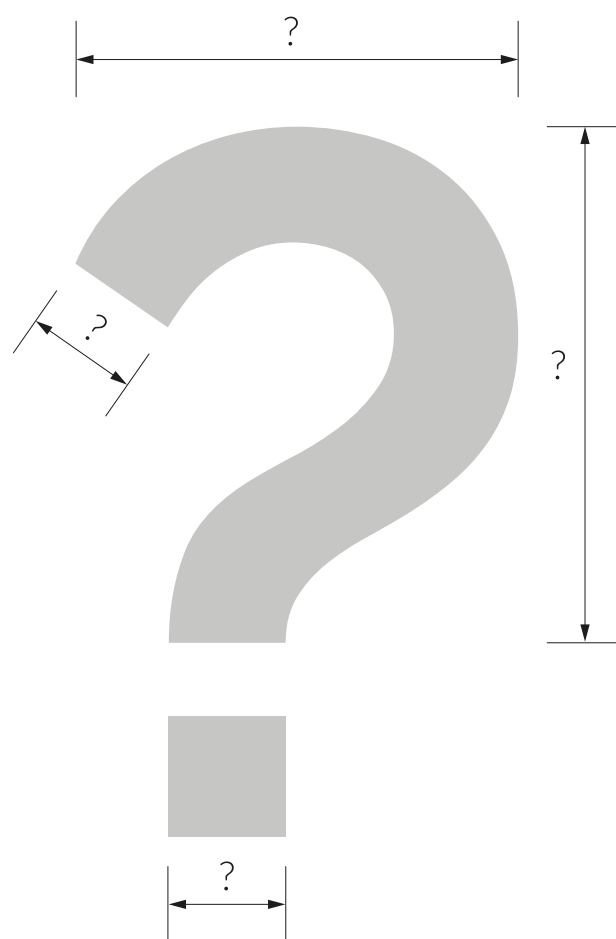

**Abbiamo ancora molti altri articoli a disposizione,
contattaci per:**

- > visionare i profili fuori catalogo
- > richiederci profili personalizzati

Contatti

+ **Tel. (+39) 0432 668877 - email info@mavisitaly.com**

